

Privia

PX-320

USER'S GUIDE

GUÍA DEL USUARIO

Please keep all information for future reference.
Guarde toda documentación para futuras consultas.

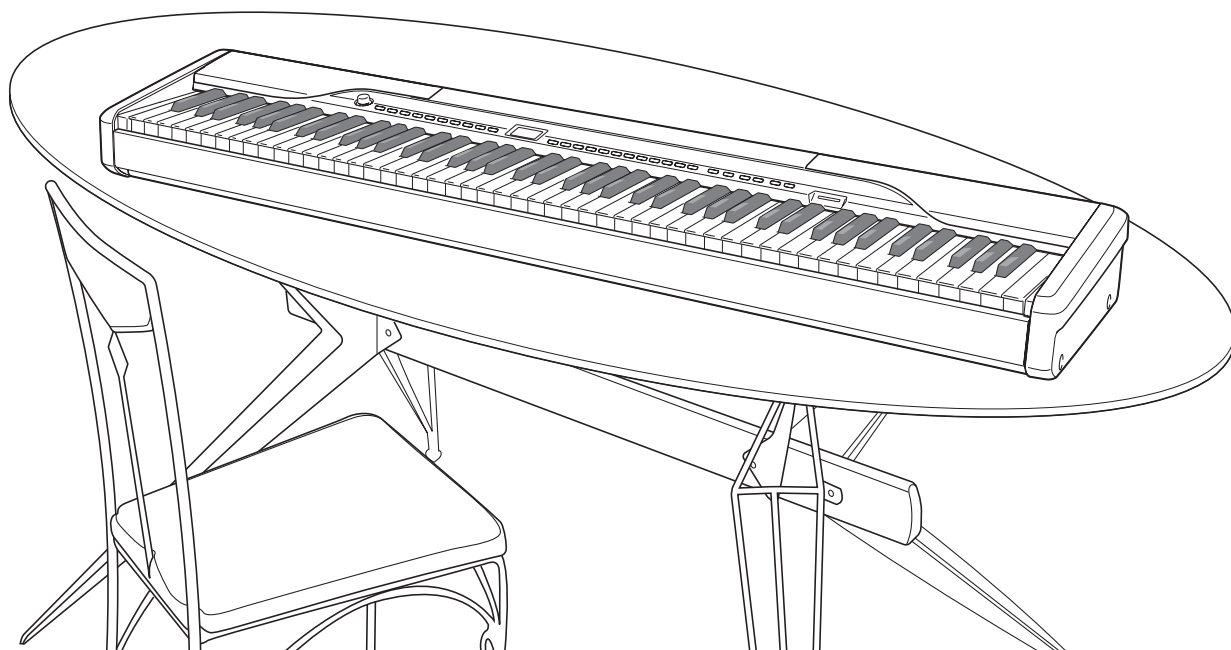
**Safety Precautions**

Before trying to use the piano, be sure to read the separate "Safety Precautions".

Precauciones de seguridad

Antes de intentar usar el piano, asegúrese de leer las "Precauciones de seguridad" separadas.

TO REDUCE THE RISK OF FIRE OR ELECTRIC SHOCK, REFER SERVICING TO QUALIFIED SERVICE PERSONNEL.

IMPORTANT SAFETY INSTRUCTIONS

1. Read these instructions.
2. Keep these instructions.
3. Heed all warnings.
4. Follow all instructions.
5. Do not use this apparatus near water.
6. Clean only with dry cloth.
7. Do not block any ventilation openings. Install in accordance with the manufacturer's instructions.
8. Do not install near any heat sources such as radiators, heat registers, stoves, or other apparatus (including amplifiers) that produce heat.
9. Do not defeat the safety purpose of the polarized or grounding-type plug. A polarized plug has two blades with one wider than the other. A grounding type plug has two blades and a third grounding prong. The wide blade or the third prong are provided for your safety. If the provided plug does not fit into your outlet, consult an electrician for replacement of the obsolete outlet.
10. Protect the power cord from being walked on or pinched particularly at plugs, convenience receptacles, and the point where they exit from the apparatus.
11. Only use attachments/accessories specified by the manufacturer.
12. Use only with the cart, stand, tripod, bracket, or table specified by the manufacturer, or sold with the apparatus. When a cart is used, use caution when moving the cart/apparatus combination to avoid injury from tip-over.



13. Unplug this apparatus during lightning storms or when unused for long periods of time.
14. Refer all servicing to qualified service personnel. Servicing is required when the apparatus has been damaged in any way, such as power-supply cord or plug is damaged, liquid has been spilled or objects have fallen into the apparatus, the apparatus has been exposed to rain or moisture, does not operate normally, or has been dropped.

The apparatus shall not be exposed to dripping or splashing and that no objects filled with liquids, such as vases, shall be placed on the apparatus.

The power indicator being unlit does not mean the apparatus is completely disconnected from the MAINS. When you need to have the apparatus completely disconnected from the MAINS, you must unplug the power cord. For that purpose, locate the apparatus in a way that secures easy access to the power cord.

Declaration of Conformity

Model Number: PX-320

Trade Name: CASIO COMPUTER CO., LTD.

Responsible party: CASIO AMERICA, INC.

Address: 570 MT. PLEASANT AVENUE, DOVER, NEW JERSEY 07801

Telephone number: 973-361-5400

This device complies with Part 15 of the FCC Rules, Operation is subject to the following two conditions:

(1) This device may not cause harmful interference, and (2) this device must accept any interference received, including interference that may cause undesired operation.

NOTICE

This equipment has been tested and found to comply with the limits for a Class B digital device, pursuant to Part 15 of the FCC Rules. These limits are designed to provide reasonable protection against harmful interference in a residential installation. This equipment generates, uses and can radiate radio frequency energy and, if not installed and used in accordance with the instructions, may cause harmful interference to radio communications. However, there is no guarantee that interference will not occur in a particular installation. If this equipment does cause harmful interference to radio or television reception, which can be determined by turning the equipment off and on, the user is encouraged to try to correct the interference by one or more of the following measures:

- Reorient or relocate the receiving antenna.
- Increase the separation between the equipment and receiver.
- Connect the equipment into an outlet on a circuit different from that to which the receiver is connected.
- Consult the dealer or an experienced radio/TV technician for help.

FCC WARNING

Changes or modifications not expressly approved by the party responsible for compliance could void the user's authority to operate the equipment.

Important!

Please note the following important information before using this product.

- Before using the AD-12 Adaptor to power the product, be sure to check the AC Adaptor for any damage first. Carefully check the power cord for breakage, cuts, exposed wire and other serious damage. Never let children use an AC adaptor that is seriously damaged.
- The product is not intended for children under 3 years.
- Use only CASIO AD-12 adaptor.
- The AC adaptor is not a toy.
- Be sure to disconnect the AC adaptor before cleaning the product.



This mark applies in EU countries only.



Manufacturer:

CASIO COMPUTER CO.,LTD.

6-2, Hon-machi 1-chome, Shibuya-ku, Tokyo 151-8543, Japan

Responsible within the European Union:

CASIO EUROPE GmbH

Bornbarch 10, 22848 Norderstedt, Germany

Contents

General Guide..... E-2

- Installing the Music Stand..... E-3
- TONE, Area Buttons (1 through 12) E-4
- Using the ▼/NO and ▲/YES Buttons..... E-5
- Saving Settings and Using Operation Lock E-5
- Returning the Digital Piano to Its Factory
Default Settings E-5

Power Outlet..... E-6

- Using an AC Adaptor..... E-6

Connections..... E-7

- Connecting Headphones E-7
- Connecting a Pedal E-7
- Connecting Audio Equipment or an Amplifier E-8

Selecting and Playing a Tone..... E-10

- To select a refined tone E-10
- To select a VARIOUS tone, GM tone, or drum set ... E-11
- To adjust the brilliance of a tone E-11
- Layering Two Tones E-12
- Splitting the Keyboard between Two Tones E-12
- Using Effects..... E-13
- Using the Metronome E-14
- Playing a Piano Duet E-15

Playing a Rhythm E-17

- Selecting a Rhythm..... E-17
- Using Auto Accompaniment E-18

Playing Back Built-in Songs E-22

- Playing Back All of the Built-in Songs..... E-22
- Playing Back a Specific Music Library Song..... E-23
- Practicing with a Music Library Song..... E-24

Saving Digital Piano Setups (Registration Memory) E-25

- To store a setup in registration memory E-26
- To recall a setup from registration memory E-27

Recording and Play Back E-28

- Songs and Tracks..... E-28
- Recording Your Keyboard Play E-29
- To play back from digital piano memory E-31
- To delete a specific track E-31

Other Settings..... E-32

- To configure other settings..... E-32
- Secondary Parameter Reference..... E-34

Connecting to a Computer E-38

- Connecting to the MIDI Terminal E-38
- Connecting to the USB Port..... E-38
- USB Mode and MIDI Mode E-39
- Expanding the Selections in the Music Library E-40

Using an SD Memory Card E-41

- Inserting and Removing an SD Memory Card E-42
- Formatting an SD Memory Card E-43
- Saving Recorded/Registration Data to an
SD Memory Card E-43
- Transferring Data from an SD Memory Card to
Digital Piano Memory E-45
- Playing Back a File Stored on an
SD Memory Card E-47
- SD Memory Card Errors..... E-48

Reference E-49

- Troubleshooting E-49
- Product Specifications..... E-51
- Operating Precautions E-52

Appendix A-1

- Tone List A-1
- Drum Assignment List..... A-3
- Rhythm List A-4
- Song List A-5
- Fingered Chord Chart A-6

MIDI Implementation Chart

Company and product names used in this manual may be registered trademarks of others.

General Guide

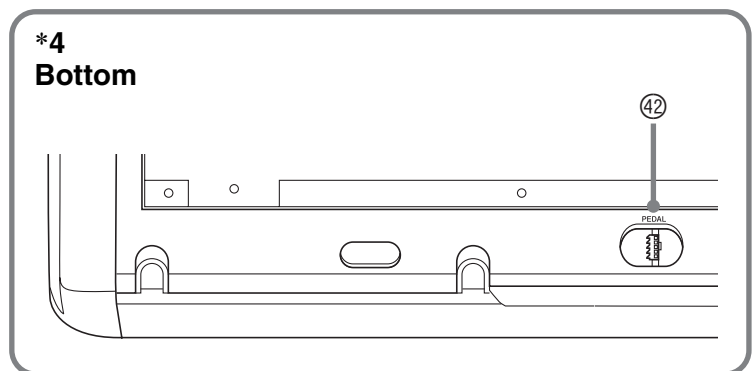
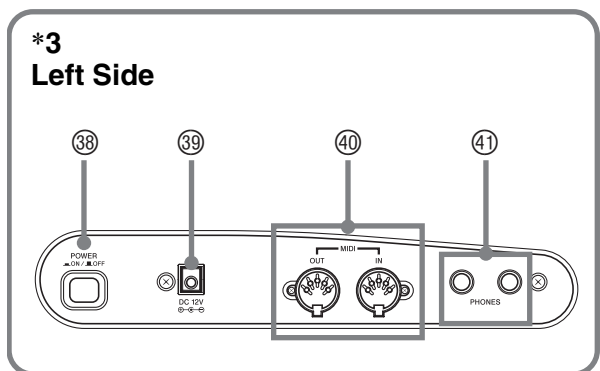
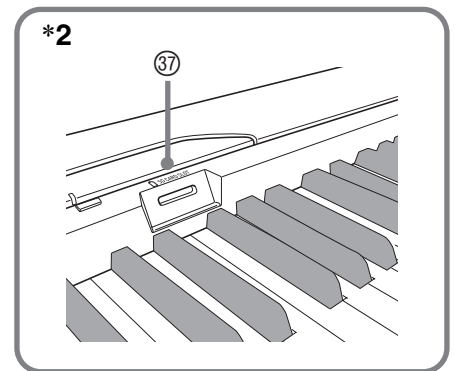
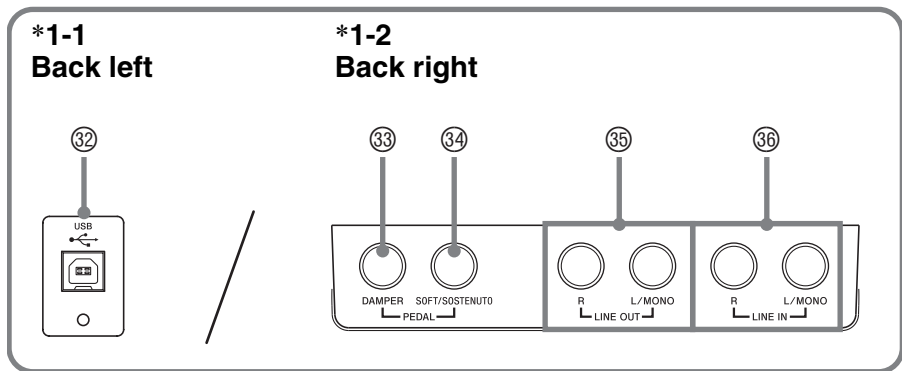
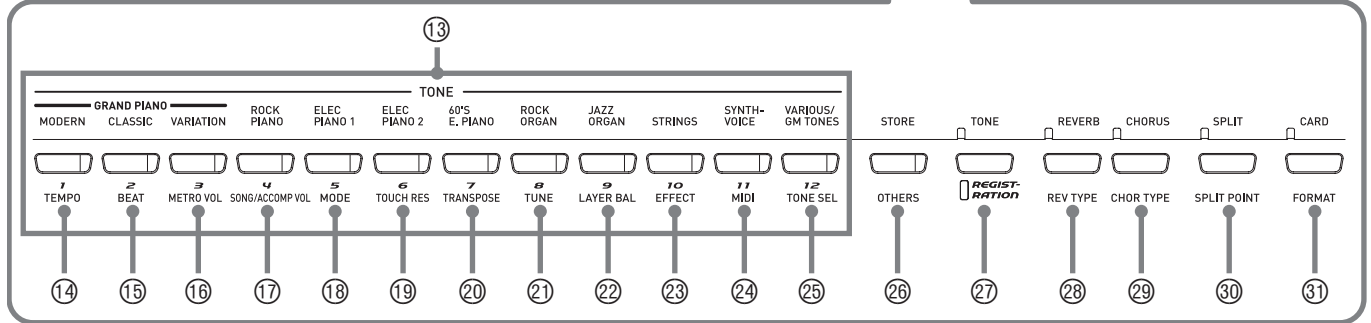
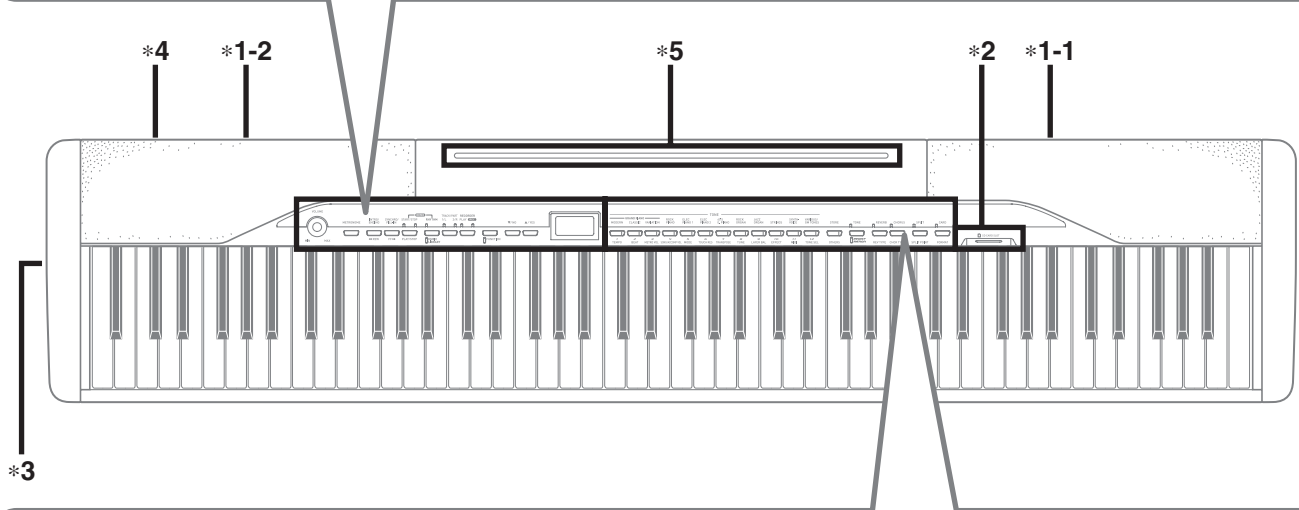
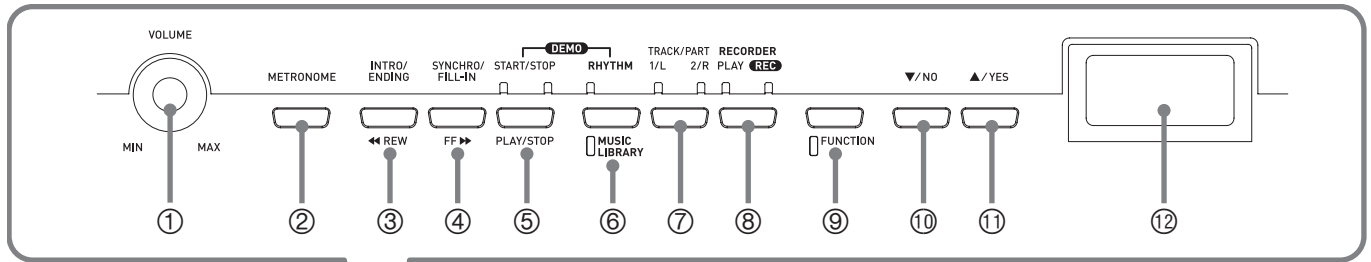

 **NOTE**

- The names shown here are always indicated in bold when they appear within the text of this manual.

- ① **VOLUME** controller
- ② **METRONOME** button
- ③ **INTRO/ENDING, ◀◀REW** button
- ④ **SYNCHRO/FILL-IN, FF▶▶** button
- ⑤ **START/STOP, PLAY/STOP** button
- ⑥ **RHYTHM, MUSIC LIBRARY** button
- ⑦ **TRACK/PART** button
- ⑧ **RECORDER** button
- ⑨ **FUNCTION** button
- ⑩ **▼/NO** button
- ⑪ **▲/YES** button
- ⑫ Display
- ⑬ **TONE**, Area buttons (1 through 12)
- ⑭ **TEMPO** button
- ⑮ **BEAT** button
- ⑯ **METRO VOL** button
- ⑰ **SONG/ACCOMP VOL** button
- ⑱ **MODE** button
- ⑲ **TOUCH RES** button
- ⑳ **TRANSPOSE** button
- ㉑ **TUNE** button
- ㉒ **LAYER BAL** button
- ㉓ **EFFECT** button
- ㉔ **MIDI** button
- ㉕ **TONE SEL** button
- ㉖ **STORE, OTHERS** button
- ㉗ **TONE/REGISTRATION** button
- ㉘ **REVERB, REV TYPE** button
- ㉙ **CHORUS, CHOR TYPE** button
- ㉚ **SPLIT, SPLIT POINT** button
- ㉛ **CARD, FORMAT** button
- ㉜ **USB** port
- ㉝ **DAMPER PEDAL** jack
- ㉞ **SOFT/SOSTENUTO PEDAL** jack
- ㉟ **LINE OUT R, L/MONO** jacks
- ㊱ **LINE IN R, L/MONO** jacks
- ㊲ **SD** memory card slot
- ㊳ **POWER** button
- ㊴ DC 12V terminal
- ㊵ **MIDI OUT/IN** terminals
- ㊶ **PHONES** jack
- ㊷ Pedal connector

*5 Installing the Music Stand

Insert the bottom of the music stand into the groove on the top of the digital piano's console.

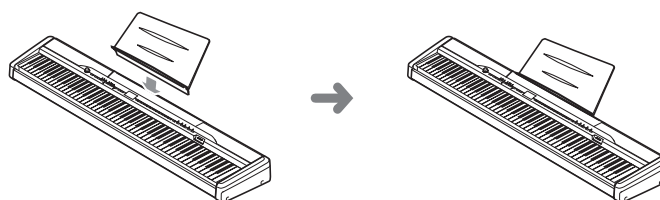

TONE, Area Buttons (1 through 12)

The following three functions are assigned the digital piano's 12 TONE, Area buttons, depending upon the type of operation you are performing.

- Tone selection (TONE buttons) (page E-10)
- Registration area selection (Area buttons) (page E-25)
- Other functions (Marked below each button.) (page E-34)

You can find out which function is currently assigned to the TONE, Area buttons by looking at the display contents and the status of each button's lamp.

Tone Selection

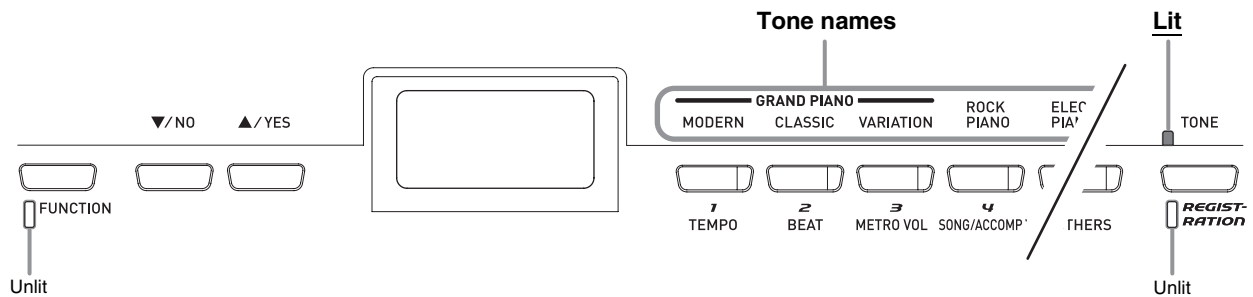

Registration Area Selection

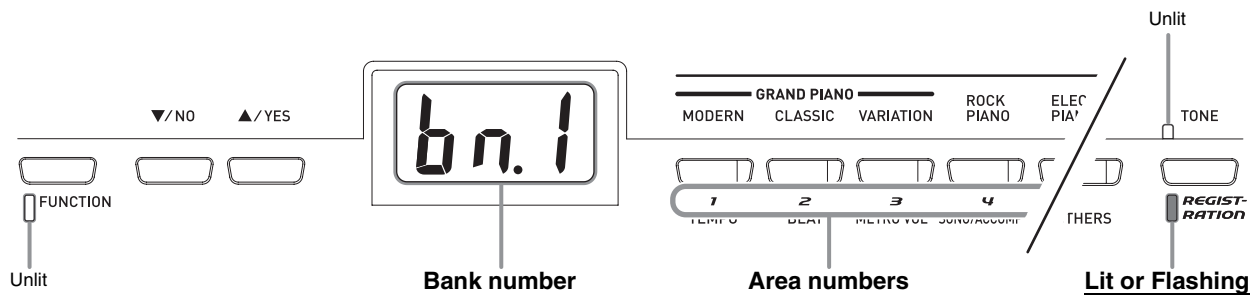

Other Settings

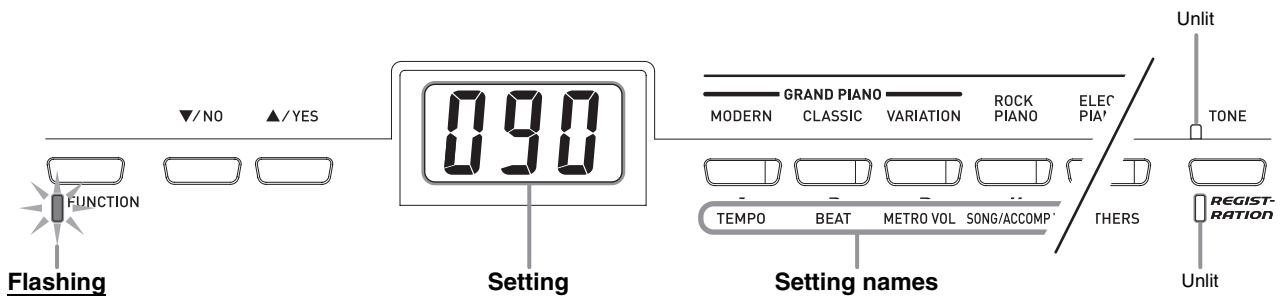

Using the ▼/NO and ▲/YES Buttons

Use the ▼/NO and ▲/YES buttons to change the currently displayed setting as you view the results of your changes on the display.

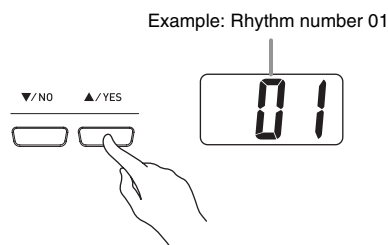

- The rhythm number (page E-17) appears first whenever you turn on the digital piano. See the applicable pages in this manual for detailed information about each type of setting.
- Each press of the ▼/NO and ▲/YES button will increase or decrease the displayed value by 1.

NOTE

- Holding down either button will scroll continually through the available settings.
- To return the displayed setting to its initial default value, press the ▼/NO and ▲/YES buttons at the same time. The initial default tempo is the recommended tempo setting for the currently selected rhythm or built-in song.

Saving Settings and Using Operation Lock

Your digital piano lets you save its current settings, and lock its buttons to protect against operation errors. For details, see “Secondary Parameter Reference” on page E-34.

Returning the Digital Piano to Its Factory Default Settings

Perform the following procedure when you want to return the digital piano’s stored data and settings to their initial factory defaults.

1. While the digital piano is turned off, hold down the **RHYTHM**, and **FUNCTION** buttons as you press the **POWER** button to turn on power.
 - This will initialize the digital piano and then perform system setup.

NOTE

- It will take some time for the digital piano initialization procedure complete. During that time, the display contents will be different from those that normally appear when you turn on power (page E-10).

Power Outlet

Your digital piano runs on standard household power. Be sure to turn off power whenever you are not using the digital piano.

Using an AC Adaptor

Use only the AC adaptor that is specified for use with this digital piano.

Specified AC Adaptor: AD-12

Left Side

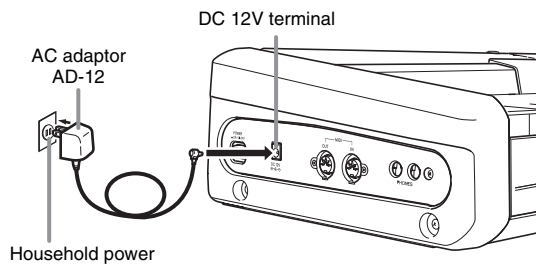

Note the following important precautions to avoid damage to the power cord.

During Use

- Never pull on the cord with excessive force.
- Never repeatedly pull on the cord.
- Never twist the cord at the base of the plug or connector.
- The power cord should not be stretched tight while it is in use.

During Movement

- Before moving the digital piano, be sure to unplug the AC adaptor from the power outlet.

During Storage

- Loop and bundle the power cord, but never wind it around the AC adaptor.



IMPORTANT!

- Make sure the digital piano is turned off before plugging in or unplugging the AC adaptor.
- The AC adaptor will become warm to the touch after very long use. This is normal and does not indicate malfunction.

Connections

Connecting Headphones

IMPORTANT!

- Before connecting headphones, be sure to use the digital piano's **VOLUME** controller to turn the volume down to a low level. After connecting, you can adjust the volume to the level you want.
- The digital piano automatically adjusts sound output to optimize for headphones (when headphones are connected) or the built-in speakers (when headphones are not connected).

Left Side

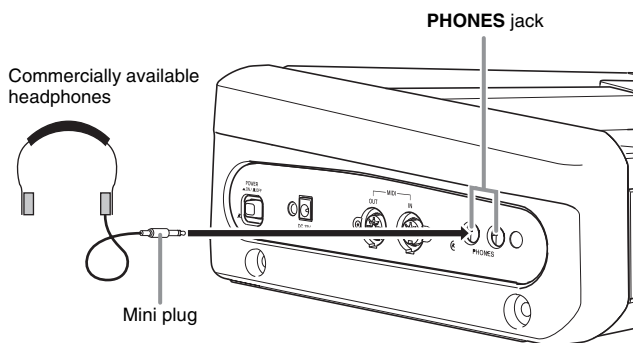

Connect commercially available headphones to the **PHONES** jack. Connecting headphones to the **PHONES** jack cuts off output to the speakers, which means you can practice even late at night without bothering others. To protect your hearing, make sure that you do not set the volume level too high when using headphones.

Connecting a Pedal

The back of the digital piano has two pedal jacks, one for a damper pedal and one for a soft/sostenuto pedal.

To connect to the pedal jack

Depending on the type of operation you want the pedal (SP-3) to perform, connect the pedal's cable either to the digital piano's **DAMPER PEDAL** jack or **SOFT/SOSTENUTO PEDAL** jack. If you want to use both operations (jack) at the same time, you need to purchase another optionally available pedal.

Back

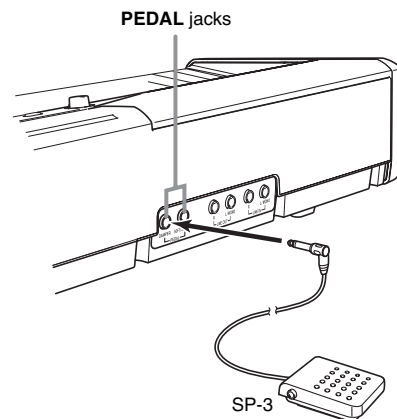

NOTE

- You can specify the type of operation that should be performed by the pedal connected to the **SOFT/SOSTENUTO PEDAL** jack. See "Other Settings" on page E-32 for more information.

Pedal Functions

● Damper Pedal

Pressing the damper pedal while playing will cause the notes you play to reverberate for a very long time.

- Whenever a piano tone is selected, pressing this pedal will activate the digital piano's Acoustic Resonance effect, which causes notes to resonate in the same way as when the damper pedal on an acoustic piano is pressed.

● Soft Pedal

Pressing this pedal suppresses notes played on the keyboard after the pedal was pressed, and makes them sound softer.

● Sostenuto Pedal

Only the notes that are played while this pedal are depressed are sustained until the pedal is released.

Pedal Connector

You can connect the optionally available 3-Pedal Unit (SP-30) to the pedal connector on the bottom of the digital piano. You can then use the pedals for expression that is similar to that available on an acoustic piano.

Bottom

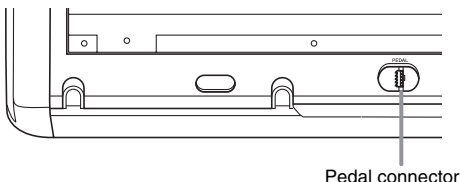

Pedal connector

NOTE

- The SP-30 Pedal Unit supports half-pedal operation (pressing the pedal part way), and you can adjust the amount of the pedal effect applied when the pedal is pressed part way. See "Other Settings" on page E-32 for more information.
- The optional CS-65P or CS-66P stand is required in order to use the SP-30 Pedal Unit.

Connecting Audio Equipment or an Amplifier

You can connect audio equipment or a music amplifier to the digital piano and then play through external speakers for more powerful volume and better sound quality.

IMPORTANT!

- The digital piano automatically adjusts sound output to optimize for headphone output (when headphones are connected) or built-in speaker output (when headphones are not connected). This also will cause a change in the output quality from the digital piano's **LINE OUT R** and **L/MONO** jacks.
- Whenever connecting something to the digital piano, first use the **VOLUME** controller to set the volume to a low level. After connecting, you can adjust the volume to the level you want.
- Whenever you connect any device to the digital piano, be sure to read the user documentation that comes with the device.

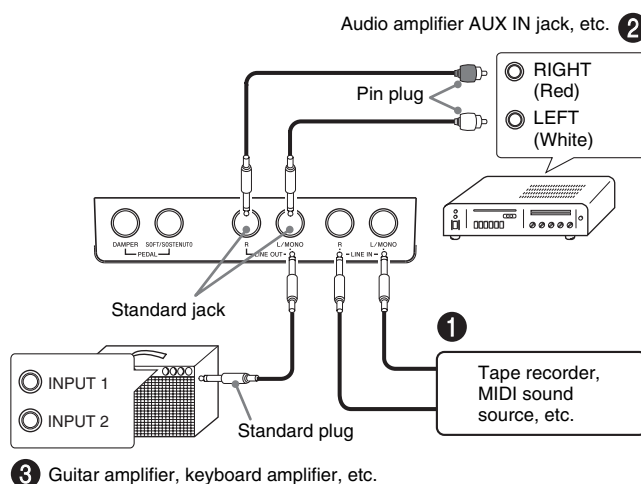

Playing Output from External Equipment through the Piano's Speakers ❶

LINE IN R jack input sounds through the piano's right speaker, while LINE IN L/MONO jack input sounds through the left speaker. Connecting to the LINE IN L/MONO jack only causes the same output to be produced from both speakers. It is up to you to purchase connecting cables that are compatible with the equipment you are connecting.

Connecting to Audio Equipment ❷

Use commercially available cables to connect the external audio equipment to the piano's LINE OUT jacks as shown in Figure ❷. LINE OUT R jack output is right channel sound, while LINE OUT L/MONO jack output is left channel sound. It is up to you to purchase connecting cables like the ones shown in the illustration for connection of audio equipment.

Normally in this configuration you must set the audio equipment's input selector to the setting that specifies the terminal (such as AUX IN) to which the piano is connected. Use the piano's VOLUME controller to adjust the volume level.

Connecting to a Musical Instrument Amplifier ❸

Use commercially available cables to connect the amplifier to the piano's LINE OUT jacks as shown in Figure ❸. LINE OUT R jack output is right channel sound, while LINE OUT L/MONO jack output is left channel sound. Connecting to the LINE OUT L/MONO jack only outputs a mixture of both channels. It is up to you to purchase connecting cable like the one shown in the illustration for connection of the amplifier. Use the piano's VOLUME controller to adjust the volume level.

Bundled and Optional Accessories

Use only accessories that are specified for use with this digital piano. Use of unauthorized accessories creates the risk of fire, electric shock, and personal injury.

Selecting and Playing a Tone

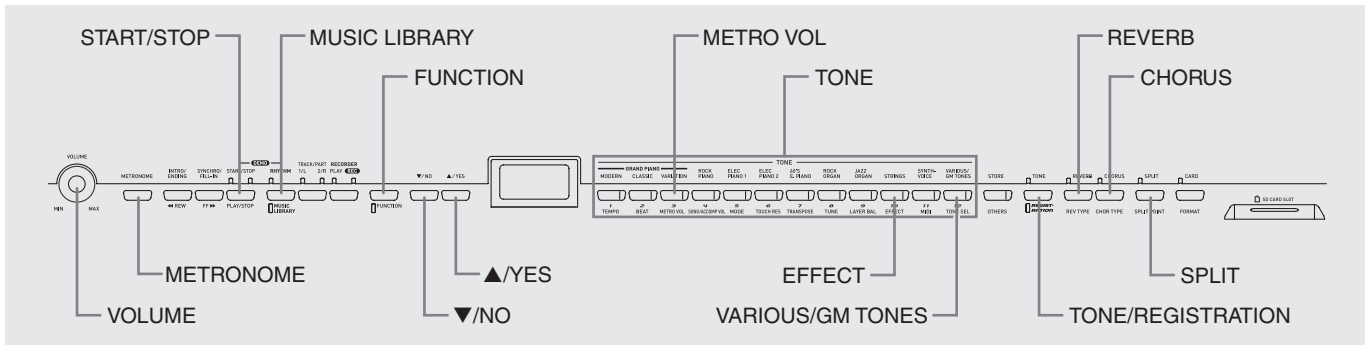

Your digital piano has the following types of tones built in.

Tone Numbers	Tone Type	Number of Tones
—	Refined Tone	11
001 to 061	Various	61
062 to 189	GM (General MIDI)	128
190 to 191	Drum Sets	2 sets

To select a refined tone

1. Press the **POWER** button to turn on the digital piano.

Left Side

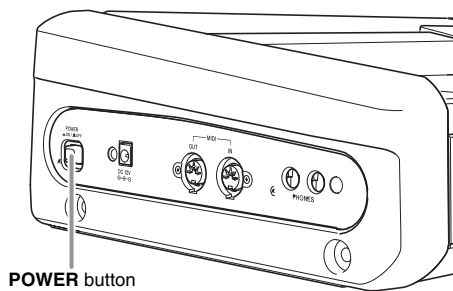

IMPORTANT!

- When you turn on the digital piano, it performs a startup routine, during which the following messages appears on the display.

- (1) : Please wait!
- (2) : System startup (Indicated by the "rotary" display pattern shown here.)
- (3) : Complete! (Keyboard and pedal setup complete.)
- (4) : Keyboard and pedal operations are enabled, but button operations are still not enabled yet.
- (5) : System setup complete
 - All functions are enabled.

- It takes about six seconds to reach process (4) after you press the **POWER** button.
- The amount of time required to perform process (2) becomes longer and process (4) is skipped if you turn on power while the digital piano's setup memory is turned on (page E-37).

2. Use the **VOLUME** controller to adjust the volume level.

- Press one of the **TONE** buttons (not the **VARIOUS/GM TONES** button) to select the tone you want.
 - The names of the refined tones are marked above the **TONE** buttons.
 - This will cause the lamp of the selected tone's button to light.

Example: GRAND PIANO (CLASSIC)

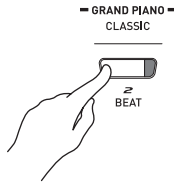

To select a **VARIOUS** tone, **GM** tone, or drum set

- Use the tone list on page A-1 to find the **VARIOUS** tone, **GM** tone, or drum set number you want.

Example: 003 MODERN PIANO

- Press the **VARIOUS/GM TONES** button.
 - The button's lamp will light indicating that the tone currently assigned to the button is lit. The tone's number will be displayed while the button is depressed.

Example: 001 LA PIANO



- You can change the tone currently assigned to the **VARIOUS/GM TONES** button by holding down the button as you use the **▼/NO** and **▲/YES** buttons to select the tone you want.



NOTE

- See "Other Settings" on page E-32 for information about another method you can use to assign a tone to the **VARIOUS/GM TONES** button.
- The tone you selected in step 3 will remain assigned to the **VARIOUS/GM TONES** button until you turn off the digital piano.
- If a drum set is assigned to the **VARIOUS/GM TONES** button, keyboard keys sound drum sounds when you press them while the lamp above the **VARIOUS/GM TONES** button is lit. See page A-3 for information about the drum sounds that are assigned to each of the keyboard keys.

To adjust the brilliance of a tone

- Press the **FUNCTION** button.
 - This will cause the button's lamp to flash.
- Press the **EFFECT** button.
 - The **EFFECT** lamp will flash and the current brilliance setting will appear on the display.



b: Brilliance

- Use the **▼/NO** and **▲/YES** buttons to set the brilliance level (-3 to 0 to 3).

To do this:	Press this button:
Make the tone softer	▼
Make the tone sharper	▲

- Press the **FUNCTION** button again.
 - This will cause the lamp below the button to go out.

Layering Two Tones

Use the following procedure to layer two tones, so they sound at the same time. The tone you specify first is called the “main tone”, while the tone you specify second is called the “layered tone”.

1. While holding down the **TONE** button of the tone that corresponds to the main tone, press the button that corresponds to the layered tone.

Example: While holding down the **GRAND PIANO (CLASSIC)** button, press the **SYNTH-VOICE** button.

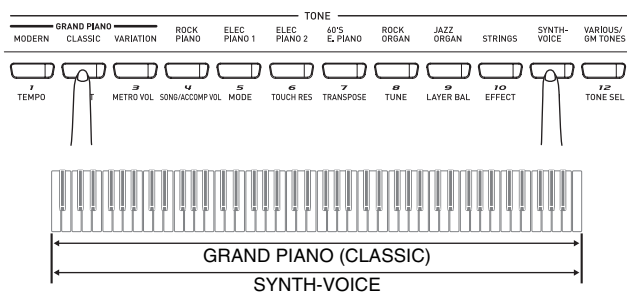

NOTE

- If you use the **VARIOUS/GM TONES** button to assign either of the above tones, the tone currently assigned to the **VARIOUS/GM TONES** button will appear on the display while the button is depressed. Note that a different tone number appears depending on whether you press the **VARIOUS/GM TONES** button first (to assign it as the main tone) or second (to assign it as the layered tone).
- While you are holding down the **VARIOUS/GM TONES** button and its tone number is displayed, you can change the currently assigned tone using the **▼/NO** and **▲/YES** buttons.

2. To unlayer the keyboard, press any one of the **TONE** buttons.

NOTE

- You can adjust the balance between the main tone and layered tone. See “Other Settings” on page E-32 for more information.
- You cannot layer the keyboard while in the Duet Mode or when recording to Track 2 on the digital piano.

Splitting the Keyboard between Two Tones

You can assign different tones to keys on the left side (low range) and the right side (high range) of the keyboard.

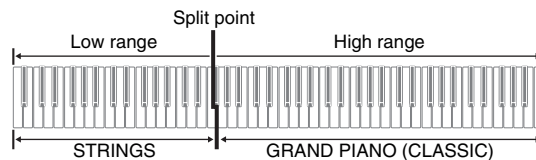

1. Press the **TONE** button of the tone you want to select for the high range.

Example: GRAND PIANO (CLASSIC)

2. Press the **SPLIT** button.

- This will cause the **SPLIT** lamp to light.

3. Press the **TONE** button of the tone you want to select for the low range.

Example: STRINGS

4. After you are finished using the split keyboard, press the **SPLIT** button again to unsplit it.

- This will cause the **SPLIT** lamp to go out.

NOTE

- You can configure the keyboard so it is layered with two tones in the high range. To do this, first perform the layer operation in the left side of this page. After that, split the keyboard as described above.
- You cannot split the keyboard while in the Duet Mode or when recording to Track 2 on the digital piano.

To specify the keyboard split point

1. While holding down the **SPLIT** button, press the keyboard key where you want the left limit of the high range (right) tone to be.

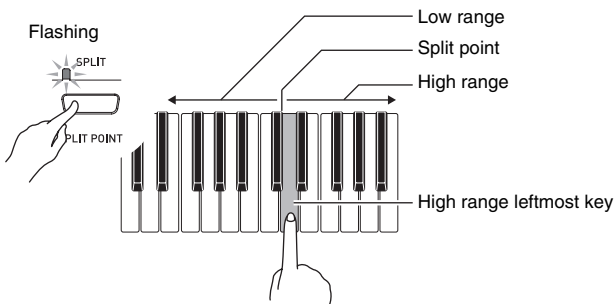

- This will change the split point and display the name of keyboard key that you pressed.



NOTE

- The split point also is the boundary between the accompaniment keyboard range (pages E-18 to E-21) and the melody keyboard range. Changing the location of the split point also changes the sizes of the keyboards.
- See "Other Settings" on page E-32 for information about another method you can use to change the split point.

Using Effects

Reverb Makes your notes resonate.

Chorus Adds more breadth to your notes.

To turn effects on and off

1. Use the **REVERB** and **CHORUS** buttons to turn the effects on and off as shown below.

- The lamps above the buttons show whether the effects are on or off.

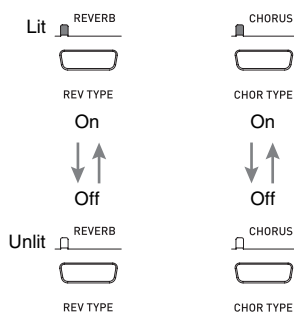

NOTE

- The chorus effect cannot be turned on while the digital piano is in the Duet Mode.

To change the effect type

1. Turn on **REVERB** or **CHORUS**.
2. While holding down the effect button (**REVERB** or **CHORUS**), use the **▼/NO** and **▲/YES** buttons to change the effect type as described below.

Reverb

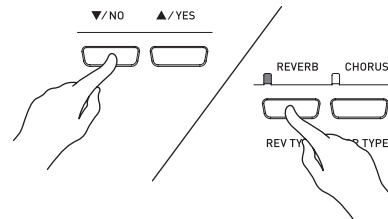

- Reverb Settings

- 1: Room
- 2: Small Hall
- 3: Large Hall
- 4: Stadium

Chorus

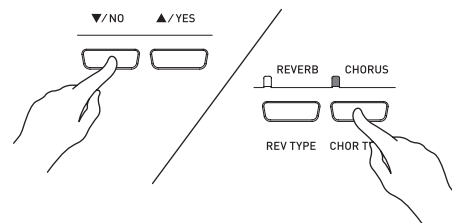

- Chorus Settings

- 1: Light Chorus
- 2: Medium Chorus
- 3: Deep Chorus
- 4: Flanger (Whooshing effect)

NOTE

- While the keyboard is layered, the chorus on/off setting affects the layered tone only. While the keyboard is split, the chorus on/off setting affects the low range tone only.

Using the Metronome

1. Press the **METRONOME** button.
 - This will start the metronome.
 - The two lamps above the **START/STOP** button will flash along with the metronome beats.

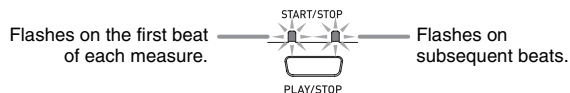

2. To change the beats per measure, hold down the **METRONOME** button as you press the **▼/NO** or **▲/YES** button.



- You can select a value in the range of 2 through 6. A chime sounds as the first beat of each measure, and the remaining beats sound as clicks. Specifying 0 as the setting plays a straight click, without any chime. This setting lets you practice with a steady beat.

3. Press the **FUNCTION** button.
 - This will cause the button's lamp to flash.
4. Use the **▼/NO** and **▲/YES** buttons to adjust the tempo in a range of 20 to 255 beats per minute.

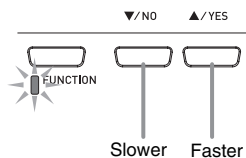
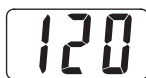

5. Press the **FUNCTION** button again.
 - This will cause the lamp above the button to go out.
6. To stop the metronome, either press the **METRONOME** button again or press the **START/STOP** button.

NOTE

- See "Other Settings" on page E-32 for information about another method you can use to configure the metronome setting.

To adjust the metronome volume

NOTE

- You can perform the following procedure at any time, regardless of whether or not the metronome is sounding.

1. Press the **FUNCTION** button.
 - This will cause the lamp above the button to flash.
2. Press the **METRO VOL** button.
 - This will cause the lamp above the button to flash.
3. Use the **▼/NO** and **▲/YES** buttons to change the metronome volume in the range of 0 to 42.



4. Press the **FUNCTION** button again.
 - This will cause the lamp above the button to go out.

Playing a Piano Duet

You can use the Duet Mode to split the piano's keyboard in the center so two people can play a duet. The left and right side keyboards have virtually the same range. If you have the optionally available SP-30 Pedal Unit installed, the left pedal operates as the left side damper pedal, while the right pedal is the right side damper pedal.

The Duet Mode is the perfect way to conduct lessons, with the teacher playing on the left side as the student plays the same song on the right side.

Keyboard

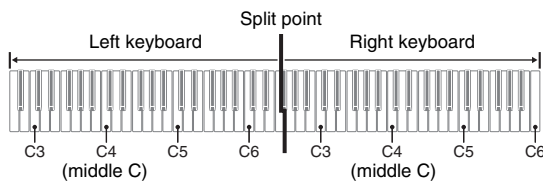

Pedals

● Using the Optional SP-30 Pedal Unit

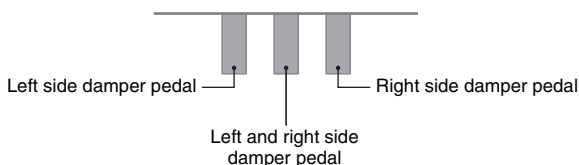

NOTE

- Only the right-side damper pedal supports half-pedal operation.

● Using the Optional SP-3 Pedal Unit

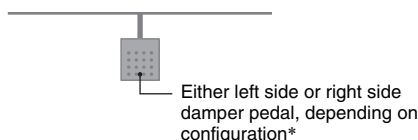

* The following are the possible configurations for the SP-3 Pedal Unit.

In this configuration:	The SP-3 Pedal Unit performs this operation:
SP-3 connected to digital piano's DAMPER PEDAL jack	Right side damper pedal
SP-3 connected to digital piano's SOFT/SOSTENUTO jack, which is configured for SOFT (page E-7)	Left side damper pedal
SP-3 connected to digital piano's SOFT/SOSTENUTO jack, which is configured for SOSTENUTO (page E-7)	Left and right side damper pedal

NOTE

- The SP-3 Pedal Unit does not support half-pedal operation.

1. Press the **MUSIC LIBRARY** button so the **MUSIC LIBRARY** lamp (below the button) is lit.

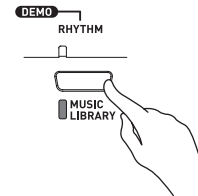

NOTE

- In place of step 1 above, you also could press the **CARD** button so the lamp above the button is lit, and then advance to step 2.

2. While holding down the **SPLIT** button, press the **TONE/REGISTRATION** button.

- This will enter the Duet Mode, which causes "dUE" to appear on the display.

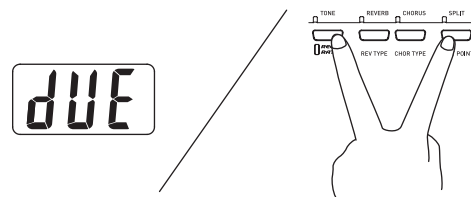

3. To exit the Duet Mode, press the **SPLIT** button.

IMPORTANT!

- The following functions are all disabled in the Duet Mode.
 - Auto Accompaniment (page E-18)
 - Registration (page E-25)
 - Recorder (page E-28)

Changing the Octaves of the Keyboards

You can change the ranges of the left and right keyboards in octave units from their initial default settings. This comes in handy, for example, if the initial default range is not enough when one person is playing the left hand part and another person is playing the right hand part.

1. While holding down the **SPLIT** button and the **TONE/REGISTRATION** button, press the keyboard key of C that you want located at C4 (middle C) of the left keyboard.

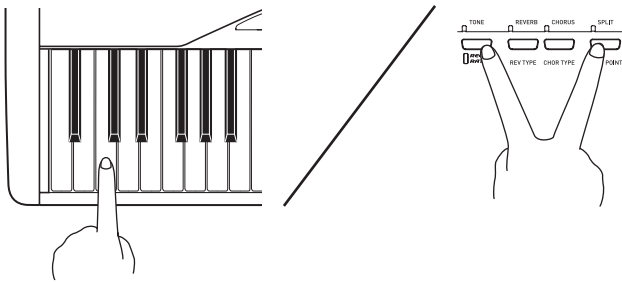

- This changes the octave of the keyboard and displays the difference between the normal keyboard (when you are not in the Duet Mode) and the current setting.



Example: Press the keyboard key of the leftmost C will assign the range shown below.

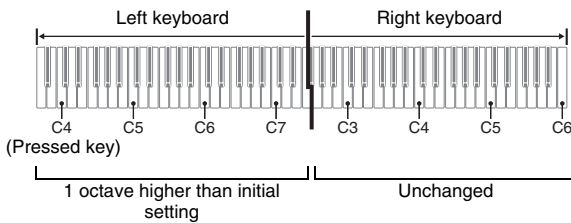

2. While holding down the **SPLIT** button and the **TONE/REGISTRATION** button, press the keyboard key of C that you want located at C4 (middle C) of the right keyboard.



NOTE

- You can return the keyboards to their initial default ranges by exiting and then re-entering the Duet Mode.

Playing a Rhythm

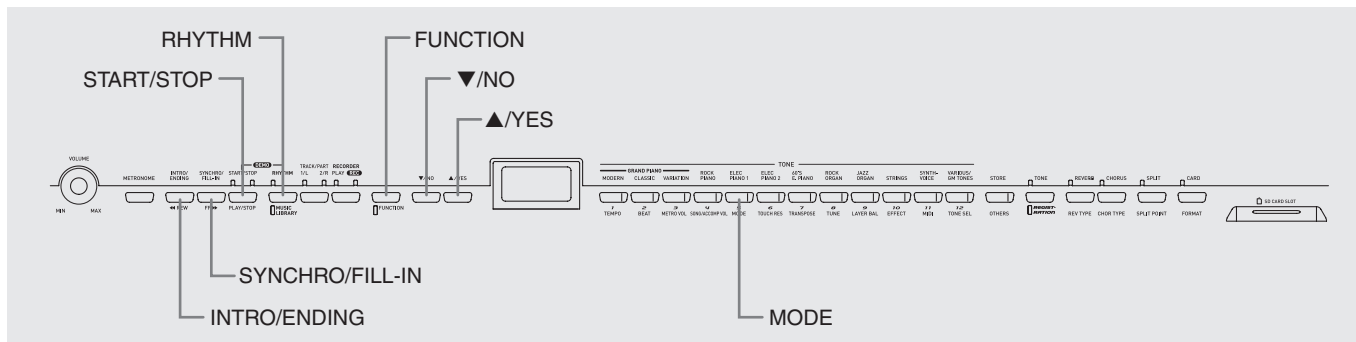

Selecting a Rhythm

You can select from among 70 built-in rhythms.

1. Press the **RHYTHM** button so the lamp above it is lit.
 - Each press of the button toggles between the lamps above and below the button.

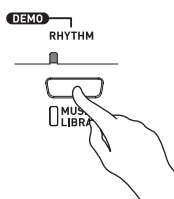

- This will cause the currently selected rhythm number to appear on the display.



2. Find the rhythm number of the rhythm you want to use in the Rhythm List on page A-4.
3. Use the **▼/NO** and **▲/YES** buttons to scroll through the rhythm numbers until the one you want is displayed.



4. Press the **START/STOP** button.
 - This will start the rhythm.
5. Press the **START/STOP** button again to stop the rhythm.

To adjust playback tempo

1. Press the **FUNCTION** button.
 - This will cause the button's lamp to flash.
2. Use the **▼/NO** and **▲/YES** buttons to change the tempo in the range of 20 to 255.



3. Press the **FUNCTION** button again.
 - This will cause the lamp above the button to go out.

Using Auto Accompaniment

With Auto Accompaniment, the digital piano automatically plays rhythm, bass, and chord parts in accordance with chords you select using simplified keyboard fingerings, or chords you play. Auto Accompaniment makes it feel like you have your own private backup group with you all the time.

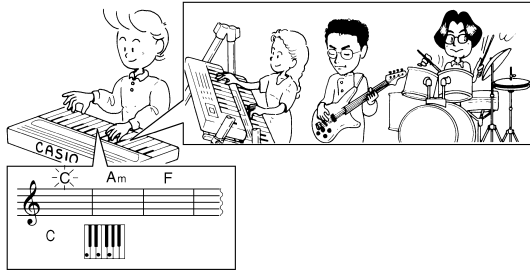

NOTE

- With the rhythms listed below, make sure that CASIO CHORD, FINGERED, or FULL RANGE CHORD is selected as the Auto Accompaniment mode before you try playing chords. The percussion sounds will sound at lower volume while no chord is fingered on the keyboard.

60	PIANO ROCK'N'ROLL
62	ARPEGGIO 1
63	ARPEGGIO 2
64	ARPEGGIO 3
65	MARCH 2
66	MARCH 3
67	STRIDE PIANO
68	WALTZ 2
69	WALTZ 3
70	WALTZ 4

To play with Auto Accompaniment

PREPARATION

- Use the procedures under "Selecting a Rhythm" to select the rhythm you want to use and adjust the tempo.

1. Press the **FUNCTION** button.
 - This will cause the button's lamp to flash.
2. Press the **MODE** button.
3. Use the **▼/NO** and **▲/YES** buttons to select one of the Auto Accompaniment modes shown below.

Display Message	Meaning
oFF	NORMAL
C.C.	CASIO CHORD
FnG	FINGERED
FUL	FULL RANGE CHORD

- Here we will select the CASIO CHORD mode.



- See "How to Play Chords" on page E-19 for details about Auto Accompaniment modes and their chord fingerings.

4. Press the **FUNCTION** button again.
 - This will cause the lamp above the button to go out.
5. Press the **SYNCHRO/FILL-IN** button.
 - This configures the digital piano so rhythm and chord accompaniment will start automatically when you press any keys within the accompaniment keyboard range.
 - This will cause the two lamps above the **START/STOP** button to flash.
6. Press the **INTRO/ENDING** button.

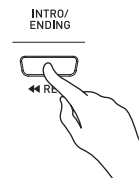

7. Finger the first chord within the accompaniment keyboard range.

- Playing a chord will cause the intro pattern for the selected rhythm to play, followed by the accompaniment rhythm and chord pattern.

8. Finger other chords on the keyboard.

- See “How to Play Chords” on page E-19 for information about how to finger chords within the different Auto Accompaniment modes.
- The two lamps above the **START/STOP** button will flash along with the beat.

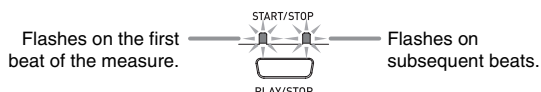

NOTE

- You can insert a fill-in pattern while a rhythm pattern is playing by pressing the **SYNCHRO/FILL-IN** button. A fill-in helps to change the mood of the pattern.

9. To stop accompaniment, press the **INTRO/ENDING** button.

- This will play an ending pattern for the selected rhythm before stopping Auto Accompaniment play.

NOTE

- You can stop accompaniment play without an intro and ending pattern by pressing the **START/STOP** button in place of steps 6 or 9.
- See “Other Settings” on page E-32 for information about adjusting accompaniment volume.

How to Play Chords

The way you finger chords depends on the current Auto Accompaniment mode. If you want to play without Auto Accompaniment, use the **NORMAL** mode.

■ CASIO CHORD

Even if you do not know how to play chords normally, this mode lets you play four different types of chords using simplified fingerings in the accompaniment keyboard range of the keyboard. The following shows where the accompaniment keyboard range is located, and explains how to finger chords in the **CASIO CHORD** mode.

CASIO CHORD Mode Keyboard

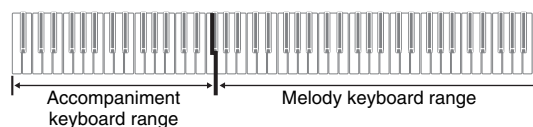

IMPORTANT!

- In the CASIO CHORD mode, the keys in the accompaniment keyboard range of the keyboard operate as “chord switches” only. You cannot use the keys in this keyboard range to play notes.
- You can use the split point to change the size of the accompaniment keyboard range. See “To specify the keyboard split point” on page E-13 for more information.

Chord Types	Example:
<p>Major Chords Pressing a single accompaniment keyboard key in the CASIO CHORD mode will play the major chord whose name is marked above the key. All of the accompaniment keyboard range keys that are marked with the same chord name play exactly the same chord.</p>	<p>C (C Major) Note names → </p>
<p>Minor Chords To play a minor chord, press the accompaniment keyboard range key that corresponds to the major chord, while also pressing one other accompaniment keyboard range key to the right.</p>	<p>Cm (C Minor) </p>
<p>Seventh Chords To play a seventh chord, press the accompaniment keyboard range key that corresponds to the major chord, while also pressing two other accompaniment keyboard range keys to the right.</p>	<p>C7 (C Seventh) </p>
<p>Minor Seventh Chords To play a minor seventh chord, press the accompaniment keyboard range key that corresponds to the major chord, while also pressing three other accompaniment keyboard range keys to the right.</p>	<p>Cm7 (C Minor Seventh) </p>

NOTE

- When playing a minor, seventh, or minor seventh chord, it makes no different whether the additional keys you press are black or white.

FINGERED

In the FINGERED mode, you play standard chord fingerings in the accompaniment keyboard range to play chords. To finger a C chord, for example, you would press the C-E-G keys.

FINGERED Mode Keyboard

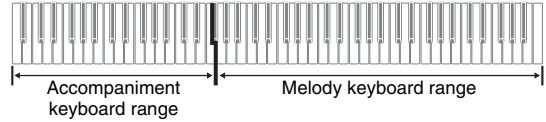

IMPORTANT!

- In the FINGERED mode, the keys in the accompaniment keyboard range of the keyboard operate as “chord switches” only. You cannot use the keys in this keyboard range to play notes.
- You can use the split point to change the size of the accompaniment keyboard range. See “To specify the keyboard split point” on page E-13 for more information.

NOTE

- See the “Fingered Chord Chart” on page A-6 for information about fingering chords with other roots in the accompaniment keyboard range.

- *1 Inverted fingerings (see “Fingered Chord Notes” on page E-21) are not supported for these chords. The lowest note fingered is used as the root.
- *2 For these chords, the same chord is specified even if the G fifth is not fingered.

Fingered Chord Notes

- Except for the chords whose names have *1 after them in the above examples, you also can use inverted fingerings. This means that fingering either E-G-C or G-C-E will produce a C chord.
- Except for the chords whose names have *2 after them in the above examples, you need to press all of the indicated keys in order to finger a chord. Failure to include even a single note may produce a chord that is different from the one you want.

■ FULL RANGE CHORD

The FULL RANGE CHORD mode lets you play a total of 38 different types of chords (the same chords available in the FINGERED mode plus 23 more). FULL RANGE CHORD recognizes the pressing of three or more keyboard keys anywhere on the keyboard as a chord fingering. Anything else (pressing one or two keys, or playing any group of notes that does not form a chord fingering that is recognized by the keyboard) is treated as melody notes.

FULL RANGE CHORD Mode Keyboard

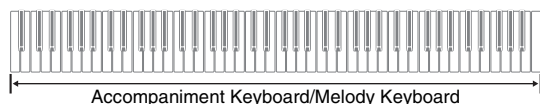

● Recognized Chords

Type	Chord Types
FINGERED Mode Chords	15 (See "FINGERED" on page E-20.)
Other Chords	23 For example, the following are chords that have C as the bass note. C ₆ , C _{m6} , C ₆₉ $\frac{D^{\flat}}{C}$, $\frac{D}{C}$, $\frac{E}{C}$, $\frac{F}{C}$, $\frac{G}{C}$, $\frac{A^{\flat}}{C}$, $\frac{B^{\flat}}{C}$, $\frac{B}{C}$, $\frac{D^{\flat}m}{C}$, $\frac{Dm}{C}$, $\frac{Fm}{C}$, $\frac{Gm}{C}$, $\frac{Am}{C}$, $\frac{B^{\flat}m}{C}$, $\frac{Ddim}{C}$, $\frac{A^{\flat}7}{C}$, $\frac{F7}{C}$, $\frac{Fm7}{C}$, $\frac{Gm7}{C}$, $\frac{A^{\flat}add9}{C}$

Example: C Major or $\frac{C}{E}$ chord

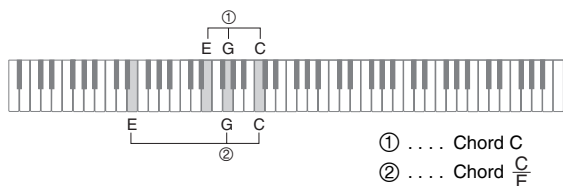

NOTE

- When there are at least six semitones between the lowest note and the next note to the right, the lowest note is assumed to be the bass note.

Playing Back Built-in Songs

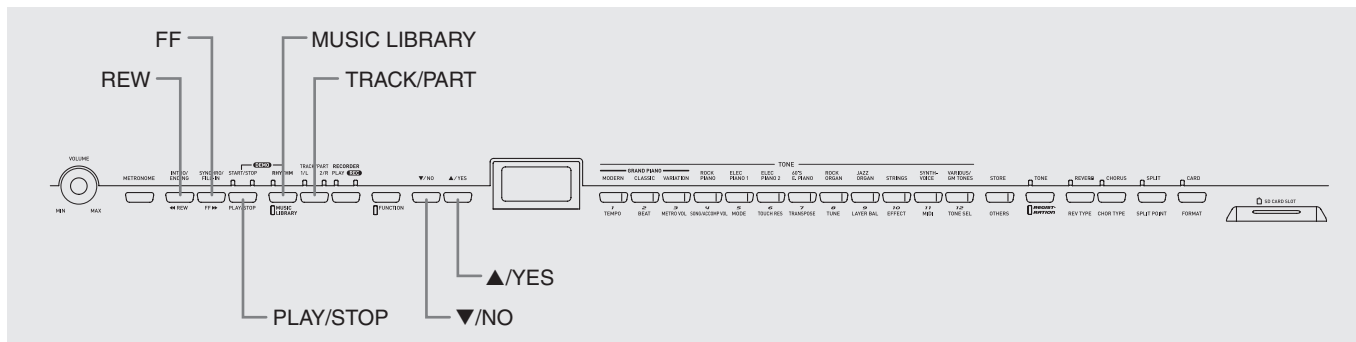

IMPORTANT!

- After you select a built-in song, it can take a number of seconds for the song data to be loaded. While the data is being loaded, the song number will flash on the display, and the keyboard keys and button operations will be disabled. Selecting a song while playing something on the keyboard will cause sound output of the keyboard notes to stop.

Playing Back All of the Built-in Songs

Your digital piano has a total of 71 built-in songs. You can use the procedure below to play back all of the songs, one after the other.

Type	Number of Songs	Indication
Refined Tone Demo Tune	11	The TONE button of the refined tone being used flashes, and the demo song number is displayed.
Music Library Song	60	The Music Library lamp flashes and the song number is displayed.

1. While holding down the **MUSIC LIBRARY** button, press the **PLAY/STOP** button.

- This will start playback of the 71 built-in songs in sequence, from t.01 through L.60.
- You can play along with a song on the keyboard during all-song playback. The tone assigned to the keyboard is the one that is preset for the song that is playing.
- You can use the **▼/NO** and **▲/YES** buttons to skip sequentially between songs during all-song playback.
- If you press a **TONE** button, playback will jump to the demo song that uses that tone. If you press the **MUSIC LIBRARY** button during all-song playback, playback will jump to Music Library song L.01.

2. Press the **PLAY/STOP** button to stop all-song playback.

Playing Back a Specific Music Library Song

The Music Library includes both built-in songs (01 to 60), plus up to 10 songs (61 to 70) that have been saved to digital piano memory from a computer* or SD memory card (page E-41). You can use the procedure below to select one of these songs and play it back.

* You can download music data from the Internet and then transfer it from your computer to digital piano memory. See "Expanding the Selections in the Music Library" on page E-40 for more information.

1. Press the **MUSIC LIBRARY** button so the lamp below the button is lit.

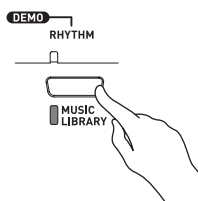

- Each press of the button toggles between the upper lamp and lower lamp.
- This will cause the currently selected song number to appear on the display.



2. Find the song number of the song you want to play in the Song List on page A-5.
3. Use the **▼/NO** and **▲/YES** buttons to select a song.



4. Press the **PLAY/STOP** button.

- This starts the playback of the song.
- The measure number appears on the display during playback.



Measure number

- To view the song number during playback, hold down the **MUSIC LIBRARY** button.
- While playback is in progress, you can press the **▼/NO** and **▲/YES** button to change to another song.

5. Press the **PLAY/STOP** button again to stop playback.
 - Playback will stop automatically when the end of the song is reached.

NOTE

- You can change tempo, volume, and pre-count settings for playback. See "Other Settings" on page E-32 for more information.

To skip back through a song

1. While playback is in progress, hold down the **REW** button.
 - This skips back through the song measure-by-measure.
 - The measure number appears on the display while you are skipping back.



Measure number

2. When you reach the point you want, release the **REW** button to resume playback.

NOTE

- Depending on what is being played when you press the **REW** button, the skip back operation may not start right away when you press.

To skip forward through a song

1. While playback is in progress, hold down the **FF** button.

- This skips forward through the song measure-by-measure.
- The measure number appears on the display while you are skipping forward.



2. When you reach the point you want, release the **FF** button to resume playback.

Practicing with a Music Library Song

You can turn off the left hand part or right hand part of a Music Library song and play along on the digital piano.

NOTE

- The Music Library includes duet tunes (song numbers 12, 37, and 45). While a duet is selected, you can turn off the first piano (Primo) or second piano (Secondo) tone and play along with the song.
- A number of tunes have tempo changes part way through in order to produce specific musical effects.

PREPARATION

- Select the Music Library song you want to practice and adjust the tempo.

1. Use the **TRACK/PART** button to turn off a part.

- Each press of the **TRACK/PART** button cycles through the part settings as shown below. The lamps above the button show which part is turned off.

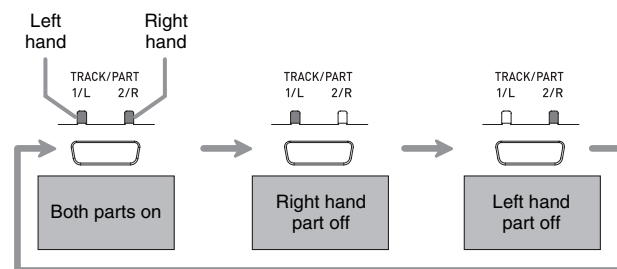

2. Press the **PLAY/STOP** button.
 - This starts playback, without the part you turned off in step 1.
3. Play the missing part on the keyboard.
4. Press the **PLAY/STOP** button again to stop playback.

Saving Digital Piano Setups (Registration Memory)

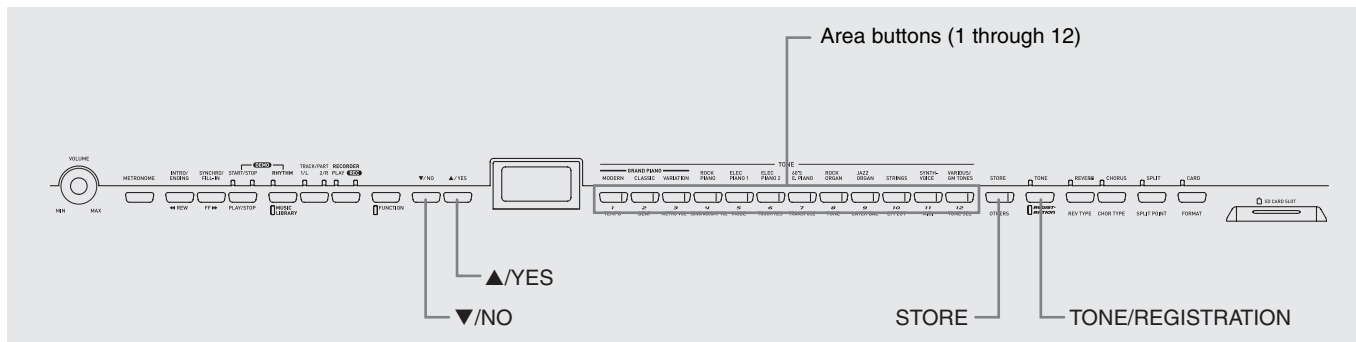

You can save up to 96 digital piano setups in registration memory, including tone, rhythm, and tempo settings, for quick and easy recall whenever you need them.

Registration Areas and Banks

Each setup is stored in an “area”. There are a total of 96 areas, which are grouped into eight “banks”.

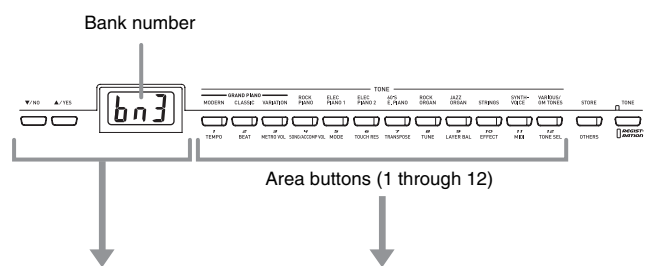

Bank 1 (bn.1)	1-1	1-2	1-3	—	1-11	1-12
Bank 2 (bn.2)	2-1	2-2	2-3	—	2-11	2-12
Bank 3 (bn.3)	3-1	3-2	3-3	—	3-11	3-12
Bank 4 (bn.4)	4-1	4-2	4-3	—	4-11	4-12
Bank 5 (bn.5)	5-1	5-2	5-3	—	5-11	5-12
Bank 6 (bn.6)	6-1	6-2	6-3	—	6-11	6-12
Bank 7 (bn.7)	7-1	7-2	7-3	—	7-11	7-12
Bank 8 (bn.8)	8-1	8-2	8-3	—	8-11	8-12

Example of area data:

Area 5-1 Tone: Strings Rhythm number: 32 Tempo: 200 :	Area 3-3 Tone: Jazz Organ Rhythm number: 40 Tempo: 110 :
---	--

Registration Data Contents

- Tone (page E-10)
- Brilliance (page E-11)
- Layer/Split (page E-12)
- Reverb/chorus (page E-13)
- Rhythm* (page E-17)
- Tempo* (page E-17)
- Mode* (page E-18)
- SYNCHRO button on/off* (page E-18)
- Accompaniment volume* (page E-35)
- Keyboard key (page E-35)
- Pedal settings (page E-36)

* These five settings can be recalled only when the RHYTHM lamp (page E-17) is lit and the registration filter is turned off (page E-36).

Registration Data Storage Notes

- Registration data is stored even when the digital piano is turned off.
- Storing new data in an area replaces any data that is currently in the same area.
- The digital piano is shipped from the factory with registration data stored in each area. You can restore this original data by performing the procedure under “Returning the Digital Piano to Its Factory Default Settings” on page E-5.
- You can save registration data to an SD memory card, if you want. See “Using an SD Memory Card” on page E-41 for more information.

IMPORTANT!

- CASIO COMPUTER CO., LTD. takes no responsibility for any damages, lost profits, or claims by third parties arising from the loss of deleted recorded data due to malfunction, repair, or for any other reason.

To store a setup in registration memory

1. On the digital piano, configure the tone, rhythm, and other settings you want to save as your setup.

- See “Registration Data Contents” (page E-25) for more information.

NOTE

- If you use the **FUNCTION** button to configure a setting, make sure that the **FUNCTION** button lamp is unlit before you advance to step 2. If the lamp is lit, press the **FUNCTION** button so it goes out.

2. While holding down the **STORE** button, use the **▼/NO** and **▲/YES** buttons to display the number of the bank where you want to store the registration data.

- This will display the bank number and then display the screen for specifying the area number.

Example: Bank 1 selected



3. While holding down the **STORE** button, press one of the area buttons (1 through 12), to select the area where you want to save the registration data.

- The lamp of the applicable area button will light after registration is complete. Also, the message “CPL” (complete) will appear on the display.

Example: After data has been saved to area 1-2

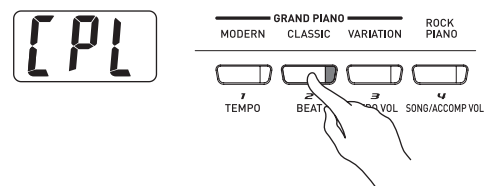

4. Release the **STORE** button.

NOTE

- Registration data cannot be stored when any one of the following conditions exists. Eliminate the problem condition and perform the procedure from step 2.
 - The digital piano is in the Duet Mode.
 - Song, rhythm, or metronome is playing.
 - Two **RECORDER** button lamps are lit or flashing.

To recall a setup from registration memory

1. Press the **TONE/REGISTRATION** button so the registration lamp is lit.
 - This will cause the currently selected bank number to appear on the display.
 - Each press of the button toggles between the upper lamp and lower lamp.

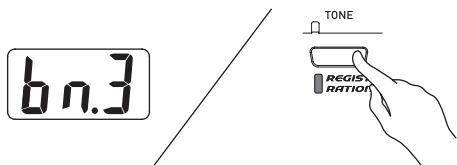

2. Use the **▼/NO** and **▲/YES** buttons to display the number of the bank that contains the area you want to recall.
3. Press the area button (1 through 12) for the area whose registration data you want to recall.
 - The lamp of the applicable area button will light after recall is complete.

Example: After data has been recalled from area 3-1

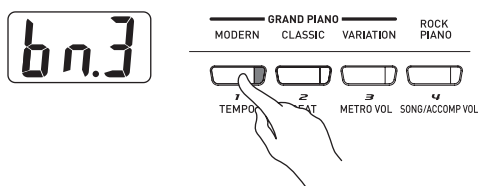

NOTE

- Registration data cannot be recalled when any one of the following conditions exists. Eliminate the problem condition and perform the procedure from step 1.
 - The digital piano is in the Duet Mode.
 - **RECORDER** button PLAY lamp is flashing.
- To check the current selected song or rhythm number while a bank number is on the display, press the **RHYTHM**, **MUSIC LIBRARY** button or **CARD** button.

Recording and Play Back

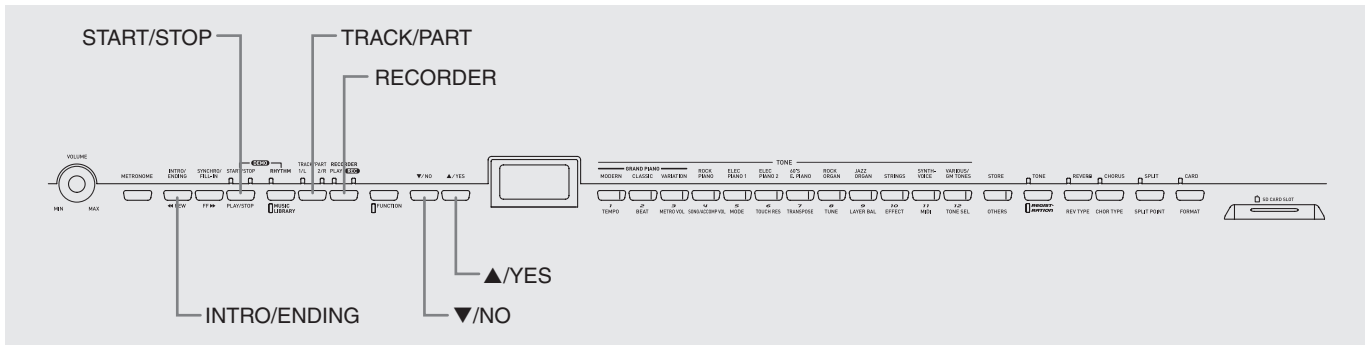

You can store the notes you play in digital piano memory for later playback. You can have up to five songs in memory at one time.

Songs and Tracks

A track is a container of recorded data, and each song consists of two tracks: Track 1 and Track 2. You can record each track separately and then combine them so they play back together as a single song.

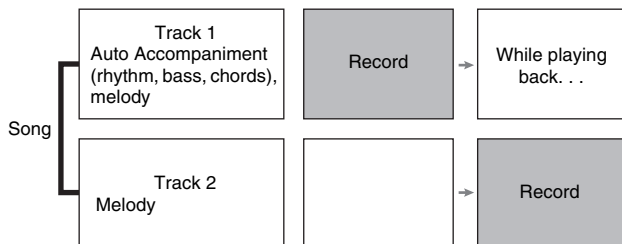

Memory Capacity

- Digital piano memory can hold about 50,000 notes total, for five songs. Each song can contain up to about 10,000 notes.
- When remaining memory capacity is 100 notes or less, the track lamp flashes at high speed to alert you.
- Recording will stop automatically and the REC lamp will go out if the number of notes in memory exceeds the maximum.

Recorded Data

- Keyboard play
- Tone used
- Pedal operations
- Reverb and chorus settings*
- Tempo setting*
- Layer and split settings*
- Rhythm Patterns*
- Chord fingering*
- Intro, fill-in, ending operations*

* Track 1 only

Recorded Data Storage

- Starting a new recording deletes any data that was previously recorded in memory.
- Should power fail during recording, all of the data in the track you are recording will be deleted.
- You can save memory data to external media, if you want. See “Using an SD Memory Card” on page E-41 for more information.

IMPORTANT!

- CASIO COMPUTER CO., LTD. takes no responsibility for any damages, lost profits, or claims by third parties arising from the deletion of recorded data due to malfunction, repair, or for any other reason.
- After you select a song, it can take a number of seconds for the song data to be loaded. While the data is being loaded, the song number will flash on the display, and keyboard key and button operations will be disabled. Selecting a song while playing something on the keyboard will cause sound output of the keyboard notes to stop.

Using the RECORDER Button

Each press of the **RECORDER** button cycles through the recording options in the sequence shown below.

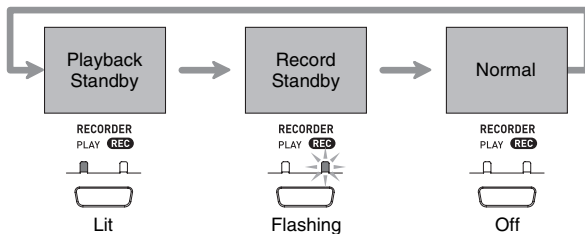

Recording Your Keyboard Play

After recording to either of the tracks of a song, you can record to the other track while listening to playback what you recorded in the first track.

To record to a specific track of a specific song

1. Press the **RECORDER** button so the **PLAY** lamp is lit.

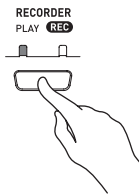

2. Use the **▼/NO** and **▲/YES** buttons to display a song number (1 to 5).



3. Press the **RECORDER** button so the **REC** lamp is flashing.

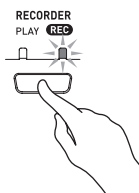

- At this time the 1/L lamp also will flash to indicate that the digital piano is standing by for recording to Track 1.



4. Use the **TRACK/PART** button to select the track to which you want to record.

- Make sure that the lamp for the record track is flashing.
Track 1: 1/L lamp
Track 2: 2/R lamp

NOTE

- If you want to record with rhythm or Auto Accompaniment, select Track 1 (1/L lamp flashing).

5. Select the tone and effects you want to use in your recording, and set the tempo you want. If you are recording to Track 1, you also can select a rhythm and accompaniment mode.

- Tone (page E-10)

Track 1 only

- Reverb and chorus (page E-13)
- Tempo (page E-17)
- Rhythm (page E-17)
- Mode (page E-18)

NOTE

- If you want the metronome to sound while you are recording, configure the beats per measure and tempo settings, and then press the **METRONOME** button. See "Using the Metronome" on page E-14 for more information.

6. Start playing something on the keyboard.

- Recording will start automatically.

NOTE

- When recording to Track 1 with rhythm or Auto Accompaniment:
Press the **START/STOP** button to start recording. You also can start recording by pressing the **SYNCHRO/FILL-IN** button and/or the **INTRO/ENDING** button, and then play a chord.
- When recording to Track 1 without rhythm or Auto Accompaniment:
Recording will start as soon as you play anything on the keyboard.

- 7.** When you are finished, press the **START/STOP** button to stop recording.
- To stop recording with a rhythm/Auto Accompaniment ending pattern, press the **INTRO/ENDING** button.
 - Stopping recording will cause the REC lamp to go out and the PLAY lamp to light.
 - To play back the track you just recorded, press the **START/STOP** button again.
- 8.** After you are finished recording or playing back, press the **RECORDER** button so the PLAY lamp and REC lamp are off.

To record to one track of a song while listening to the playback of the other track

- 1.** Press the **RECORDER** button so the PLAY lamp is lit.

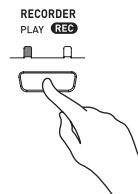

- 2.** Use the **▼/NO** and **▲/YES** buttons to display a song number (1 to 5).



This indicator appears when the track contains recorded data already.

- 3.** Press the **RECORDER** button so the REC lamp is flashing.

- This will cause the 1/L lamp to flash.

- 4.** Use the **TRACK/PART** button to select the track to which you want to record.

- Make sure that the lamp for the record track is flashing.

Example: To listen to playback of Track 1 as you record to Track 2

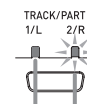

Lit: Playback standby Flashing: Record standby

- 5.** Select the tone and effects you want to use for your recording.
- 6.** Press the **START/STOP** button or play something on the keyboard to start simultaneous playback from Track 1 and recording to Track 2.
- This will start both playback of the recorded track and recording to the other track.
- 7.** When you are finished, press the **START/STOP** button again to stop recording.

To play back from digital piano memory

1. Press the **RECORDER** button so the **PLAY** lamp is lit.

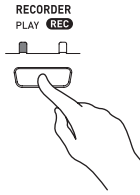

2. Use the **▼/NO** and **▲/YES** buttons to display a song number (1 to 5).



NOTE

- When a song has something recorded in both tracks, you can turn off one track and play back just the other track, if you want. Whether a track is on or off is indicated by the lamps above the **TRACK/PART** button. Each press of the **TRACK/PART** button cycles through the different possible track on/off settings.

3. Press the **START/STOP** button.

- This starts playback of the song and/or track you selected.

NOTE

- You can change the tempo setting as a track is playing.
- You cannot change the tone setting during playback.
- Press the **START/STOP** button again to stop playback.

To delete a specific track

IMPORTANT!

- The procedure below deletes all of the data of the selected song. Note that the delete operation cannot be undone. Check to make sure you really do not need the data before you perform the following steps.

1. Press the **RECORDER** button so the **PLAY** lamp is lit.
2. Use the **▼/NO** and **▲/YES** buttons to display a song number (1 to 5).
3. Press the **RECORDER** button so the **REC** lamp is flashing.

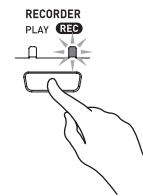

4. Use the **TRACK/PART** button to select the track you want to delete.
 - This will cause the lamp of the selected track to flash.
5. Hold down the **RECORDER** button until “dEL” (delete) appears on the display.



6. Press the **▲/YES** button.
 - This will delete the selected track and enter record standby.
 - To cancel the operation, press the **▼/NO** button in place of the **▲/YES** button.

NOTE

- All digital piano operations except for the **RECORDER** button and the **▼/NO** and **▲/YES** buttons are disabled from step 5 until the delete operation is executed in step 6 of the above procedure.

To change the setting of one of the EFFECT button parameters

Press the **EFFECT** button in step 3 of the “To configure other settings” procedure to toggle between the two parameters shown below.

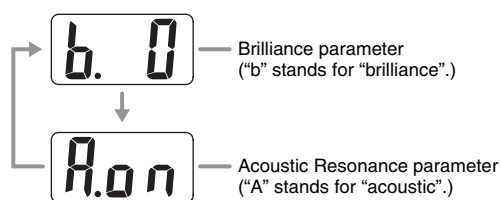

To change the setting of one of the MIDI button parameters

Press the **MIDI** button in step 3 of the “To configure other settings” procedure to cycle between the parameters shown below.

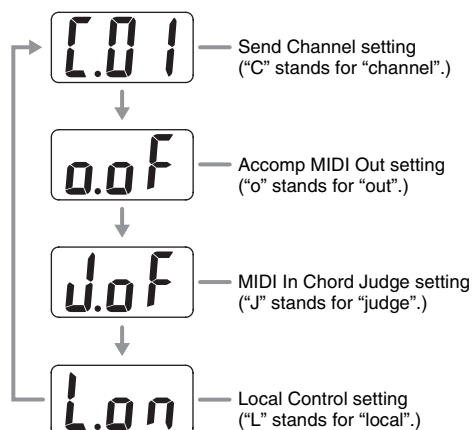

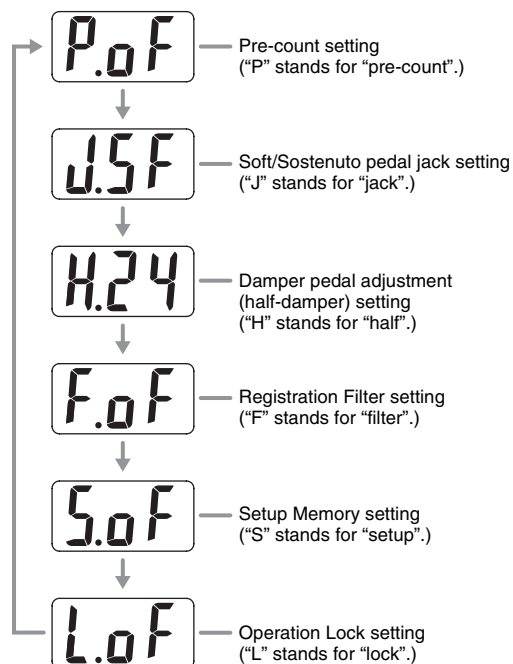

To change the setting of one of the OTHERS button parameters

Press the **OTHERS** button in step 3 of the “To configure other settings” procedure to cycle between the parameters shown below.











Secondary Parameter Reference

■ Tones

Setting	Parameter Name	Settings	Description
VARIOUS/GM TONES button assignment	TONE SEL	See "Tone List" on page A-1.	Assigns one of the digital piano's Various tone, GM tone, or Drum set to the VARIOUS/GM TONES button.
Tone layering volume balance	LAYER BAL	-24 to 0 to 24	Specifies the volume balance between the main and layered tones. A lower value reduces the volume level of the layered tone.  NOTE <ul style="list-style-type: none"> The tone layering volume balance can not be changed in the Duet Mode.
Split point	SPLIT POINT	A0 to C8*	See page E-12.
Reverb type	REV TYPE	1 to 4	See page E-13.
Chorus type	CHOR TYPE	1 to 4	See page E-13.
Brilliance level	EFFECT	b.-3 to b.0 to b.3	See page E-11.
Acoustic Resonance	EFFECT	A.oF: Off A.on: On	When the damper pedal is pressed, acoustic resonance reproduces the harmonic resonance similar to that of a grand piano. This parameter turns acoustic resonance on or off. When configuring the setting of this parameter, use the procedure under "To change the setting of one of the EFFECT button parameters" on page E-33.  NOTE <ul style="list-style-type: none"> Whether or not this effect can be applied depends on the tone. For details, see "Tone List" on page A-1.

* Split Point Key Name Display

Display									
Settings	A	B	C	D	E	F	G	F#3	Bb5

■ Song, Rhythm, and Metronome

Setting	Parameter Name	Settings	Description
Tempo	TEMPO	20 to 255	Specifies the tempo of Music Library songs, the metronome, Auto Accompaniment playback, recording and playback, etc.
Metronome beats per measure	BEAT	0, 2 to 6	Specifies the metronome beat. (page E-14)
Metronome volume	METRO VOL	0 to 42	Specifies the metronome volume. (page E-14)
Song, Auto Accompaniment volume	SONG/ACCOMP VOL	0 to 42	Specifies the volume of rhythm and chord accompaniment and built-in songs, independent of overall volume control.
Pre-count	OTHERS	P.oF: Off P.on: On	Turns the pre-count before playback of a Music Library song on or off. When configuring the setting of this parameter, use the procedure under "To change the setting of one of the OTHERS button parameters" on page E-33.  NOTE <ul style="list-style-type: none"> When playing a song from the user area or from an SD memory card, the pre-count may not sound, even though the pre-count setting is turned on.
Auto Accompaniment mode	MODE	oFF : NORMAL C.C. : CASIO CHORD FnG : FINGERED FUL : FULL RANGE CHORD	Specifies the Auto Accompaniment mode.

■ Keyboard



Setting	Parameter Name	Settings	Description
Keyboard touch response	TOUCH RES	oFF : Off 1 : Strong sound is produced even when relatively light pressure is applied. 2 : Normal 3 : Normal sound is produced even when relatively strong pressure is applied.	Specifies the relative touch of the keyboard keys.
Keyboard Key	TRANSPOSE	-12 to 0 to 12	Raises or lowers the tuning of the digital piano in semitone steps.  NOTE <ul style="list-style-type: none"> Using TRANSPOSE to raise the key of the digital piano can cause notes at the highest range of a tone to become distorted. The transpose setting cannot be configured while Music Library playback is in progress and in the Duet Mode.
Keyboard tuning	TUNE	-99 to 0 to 99	Raises or lowers the overall pitch of the digital piano to match another instrument. The setting range is plus or minus 99 cents (100 cents = 1 semitone) from the standard pitch of A4 = 440.0Hz.

■ Pedals

Setting	Parameter Name	Settings	Description
Soft/Sostenuto pedal jack setting	OTHERS	J.SF: Soft J.SS: Sostenuto	Soft pedal is the initial power on default setting for a pedal connected to the digital piano's SOFT/SOSTENUTO PEDAL jack. This parameter can be used to change the pedal to a sostenuto pedal. When configuring the setting of this parameter, use the procedure under "To change the setting of one of the OTHERS button parameters" on page E-33.
Damper pedal adjustment (half-damper)	OTHERS	H.00 to H.42	<p>■ With optional SP-30 only</p> <p>Adjusts the pedal effect applied when the damper pedal is half-pressed as a value from 0 (no effect) to 42 (same a full press). When configuring the setting of this parameter, use the procedure under "To change the setting of one of the OTHERS button parameters" on page E-33.</p>

■ MIDI and Other Settings

Setting	Parameter Name	Settings	Description
Send channel	MIDI	C.01 to C.16	Specifies one of the MIDI channels (1 through 16) as the Send Channel, which is used for sending MIDI messages to an external device. When configuring the setting of this parameter, use the procedure under "To change the setting of one of the MIDI button parameters" on page E-33.
Accomp MIDI out	MIDI	o.oF: Off o.on: On	Specifies whether or not MIDI messages should be sent in accordance with the digital piano's Auto Accompaniment and recording function playback. When configuring the setting of this parameter, use the procedure under "To change the setting of one of the MIDI button parameters" on page E-33.
MIDI In Chord judge	MIDI	J.oF: Off J.on: On	Specifies whether chord judge should be performed on accompaniment range MIDI Note On messages received from an external device. When configuring the setting of this parameter, use the procedure under "To change the setting of one of the MIDI button parameters" on page E-33.
Local control	MIDI	L.oF: Off L.on: On	When Local Control is turned on, pressing the keyboard's keys plays the notes using the currently selected built-in tone, and also sends the applicable MIDI messages out the MIDI OUT port. Turning off Local Control cuts off the digital piano's sound source, so no sound is produced by the digital piano when keys are pressed. This capability comes in handy when you want to turn off the digital piano's keyboard and play on an external sequencer or other device. When configuring the setting of this parameter, use the procedure under "To change the setting of one of the MIDI button parameters" on page E-33.
Registration Filter	OTHERS	F.oF: Off F.on: On	When Registration Filter is turned on, the rhythm and Auto Accompaniment related settings are not recalled when recalling registration data. For details about the settings that are not recalled, see "Registration Data Contents" on page E-25. When configuring the setting of this parameter, use the procedure under "To change the setting of one of the OTHERS button parameters" on page E-33.

Setting	Parameter Name	Settings	Description
Setup Memory	OTHERS	S.oF: Off S.on: On	<p>When "On" is selected for this setting, the digital piano will remember its current settings*, and restore them when it is turned on again.</p> <p>When "Off" is selected, settings are reset to their initial defaults whenever the digital piano is turned on.</p> <p>When configuring the setting of this parameter, use the procedure under "To change the setting of one of the OTHERS button parameters" on page E-33.</p> <p> NOTE</p> <ul style="list-style-type: none"> • To clear current setup memory contents, turn the Setup Memory setting off and then back on again. • The setup memory setting cannot be changed while Music Library playback is in progress, while a rhythm or the metronome is sounding, in the Duet Mode, and during recording.
Operation Lock	OTHERS	L.oF: Off L.on: On	<p>Selecting "On" for this setting locks the digital piano's buttons (except for the POWER button and the buttons required for unlock), so no operation can be performed. Turn on operation lock when you want to protect against unintentional button operations.</p> <p>When configuring the setting of this parameter, use the procedure under "To change the setting of one of the OTHERS button parameters" on page E-33.</p> <p> NOTE</p> <ul style="list-style-type: none"> • The operation lock setting cannot be changed while Music Library playback is in progress, while a rhythm or the metronome is sounding, and during recording.

* Setup Memory Data Contents

Tone selection, layer/split on/off, reverb/chorus on/off, rhythm number, SD memory card playback selection, settings on pages E-34 through E-37 (except **VARIOUS/GM TONES** button assignment, Accomp MIDI out, MIDI In Chord judge, Local control, Operation Lock), **RHYTHM/MUSIC LIBRARY** button setting, **TONE/REGISTRATION** button setting, **CARD** button setting.

Connecting to a Computer

Connecting to the MIDI Terminal

What is MIDI?

MIDI is a standard for digital signals and connectors that allows musical instruments, computers, and other devices, regardless of manufacturer, to exchange data with each other.

NOTE

- For details about MIDI implementation, visit: <http://world.casio.com/>

MIDI Connections

Connecting your computer or other external MIDI device to the digital piano's **MIDI OUT/IN** terminals makes it possible for them to exchange MIDI messages. You also can playback notes you play on the digital piano on the connected device.

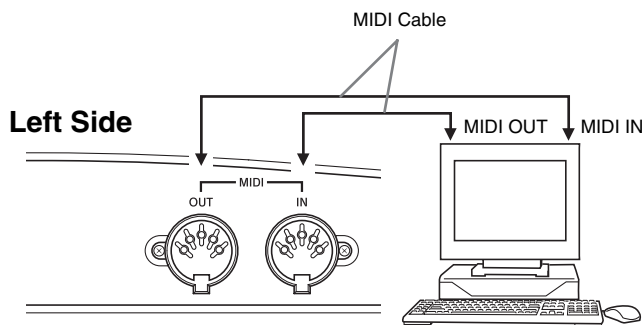

MIDI Settings

You can use the procedure in "Other Settings" (page E-32) to configure MIDI settings. See page E-34 for a description of the settings and information about how to configure them.

Connecting to the USB Port

The digital piano's **USB** port makes it quick and simple to connect to a computer.

You can install a USB MIDI driver from the CD-ROM that comes bundled with the digital piano onto a computer equipped with a **USB** port. After that, you can connect the digital piano to your computer and run commercially available MIDI software on your computer to exchange MIDI data with the digital piano. You also can use the USB connection to transfer files you downloaded from the **CASIO MUSIC SITE** from your computer to the digital piano.

You will need a commercially available USB cable to connect a computer to the digital piano's **USB** port.

To connect to a computer using the USB port

1. On the computer to which you plan to connect, install the USB MIDI driver from the CD-ROM that comes bundled with the digital piano.

NOTE

- Before installing the USB MIDI driver, be sure to read the contents of the "readme.txt" file in the "English" folder on the bundled CD-ROM.
- For details about how to install the USB MIDI driver, see the "CASIO USB MIDI Driver User's Guide" (manual_e.pdf) that also is on the bundled CD-ROM.

2. Use a commercially available USB cable (A-B type) to connect the digital piano to the computer.

IMPORTANT!

- Make sure that the digital piano is turned off before connecting or disconnecting the USB cable.

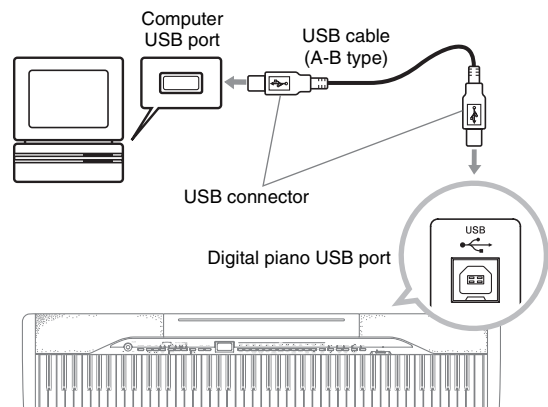

- You need to have Adobe Reader or Acrobat Reader installed on your computer in order to [view the contents of the “CASIO USB MIDI Driver User’s Guide” \(manual_e.pdf\)](#). If your computer does not have Adobe Reader or Acrobat Reader installed already, use the procedure below to install it.

To install Adobe Reader (Acrobat Reader)

- Place the CD-ROM that comes with the digital piano into your computer’s CD-ROM drive.
- On the CD-ROM, navigate to the “Adobe”/ “English” folder and double-click “ar601enu.exe” (or “ar505enu.exe”). Follow the instructions that appear on your computer screen to install the driver.

IMPORTANT!

- Adobe Reader cannot be installed using the “ar601enu.exe” file on a computer running Windows 98. If your computer is running Windows 98, click “ar505enu.exe” to install Acrobat Reader.

Minimum Computer System Requirements for the USB MIDI Driver

- Universal**
 - Operating System
Windows Vista™ (32-bit), Windows® XP Professional (32-bit), Windows® XP Home Edition, Windows® 2000 Professional, Windows® Me, Windows® 98SE, Windows® 98
 - IBM AT or compatible computer
 - USB port that provides normal operation under Windows
 - CD-ROM drive (for installation)
 - At least 2MB of free hard disk space (not including space required for Acrobat Reader)
- Windows Vista, Windows XP**
 - Pentium 300MHz or higher
 - 128MB minimum memory
- Windows 2000**
 - Pentium 166MHz or higher
 - 64MB minimum memory
- Windows Me, Windows 98SE, Windows 98**
 - Pentium 166MHz or higher
 - 32MB minimum memory

Attention Windows Vista users!

- If your computer is running Windows Vista, the MIDI device selection screen of the MIDI application software you are using may show a MIDI OUT device name in the menu of MIDI IN items, or a MIDI IN device name in the menu of MIDI OUT items. Note that selecting the wrong type of item for MIDI IN or MIDI OUT will result in a setup error. If a setup error occurs, reconfigure the MIDI device settings, taking care to select the proper items for MIDI IN and MIDI OUT. For details about configuring settings, see the user documentation that comes with your MIDI application software.

USB Mode and MIDI Mode

Your digital piano has two data communication modes: a USB mode and a MIDI mode.

The digital piano will enter the USB mode automatically whenever a connection is established between it and the USB driver running on a connected computer. If there is no computer connected to the USB port, the digital piano will enter the MIDI mode.

● USB Mode



The above message appears for about three seconds after a USB connection is established. For details about using the MIDI device functions in the USB mode, see the “CASIO USB MIDI Driver User’s Guide” (manual_e.pdf) on the bundled CD-ROM.

● MIDI Mode



The above message appears for about three seconds after a USB connection terminated. The MIDI mode is used when sending and receiving data over the digital piano’s MIDI terminals.

Expanding the Selections in the Music Library

You can store up to 10 songs you have downloaded with your computer as songs 61 through 70 of the Music Library and practice along with them as they play, just as you do with the built-in songs.

You also can use the CASIO SMF conversion software (SMF Converter) to convert SMF data files you have purchased or created, and transfer them to the digital piano's Music Library.

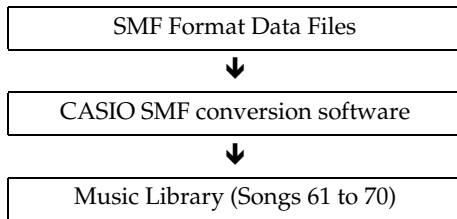

NOTE

- You will not be able to transfer data from a computer to the digital piano during playback or recording of song data, during a data save or recall operation, etc. Wait until the current operation is complete before transferring data.

To install the SMF conversion software (SMF Converter)

- Place the CD-ROM that comes with the digital piano into the CD-ROM drive of a computer that is equipped with a USB port.
- Navigate to the CD-ROM and then double-click the "SMFConv-e.exe" file. Next, follow the instructions that appear on your computer screen to install the software.
 - Before installing SMF Converter, be sure to read the contents of the "smfreadme.txt" file. A version of this file is provided in each language folder on the CD-ROM.

For information about using SMF Converter, double-click [index.html] in the [help] folder, which was created when you installed SMF Converter. You also can access user documentation from the Windows [Start] menu by clicking [Programs] – [CASIO] – [SMF Converter] – [manual].

A browser that supports frames (like Internet Explorer 4 or Netscape Navigator 4.04 or higher) is required to view the SMF Converter manual.

Minimum Computer System Requirements for SMF Converter

● Operating System

Windows Vista™ (32-bit), Windows® XP Professional (32-bit), Windows® XP Home Edition, Windows® Me, Windows® 98SE

● Storage

At least 10 MB of available disk space

● USB Interface

You also can download the SMF conversion software from the CASIO Website.

CASIO MUSIC SITE
<http://music.casio.com/>

In addition to the software itself, the CASIO MUSIC SITE also will provide you with information about its installation and use. You also can find out the latest news about your digital piano and other CASIO musical instruments, and much more.

NOTE

- Your digital piano supports SMF Format 0 and Format 1.

IMPORTANT!

- If your computer is running Windows Vista, note the precautions under "Attention Windows Vista users!" on page E-39. If a setup error occurs, perform the following steps to reconfigure settings.
 - Restart SMF Converter.
 - Open any file and display the "Selection" screen.
 - Click "Setup(S)" to display the "MIDI Device" screen.
 - Select the proper items and then exit MIDI device setup.

Using an SD Memory Card

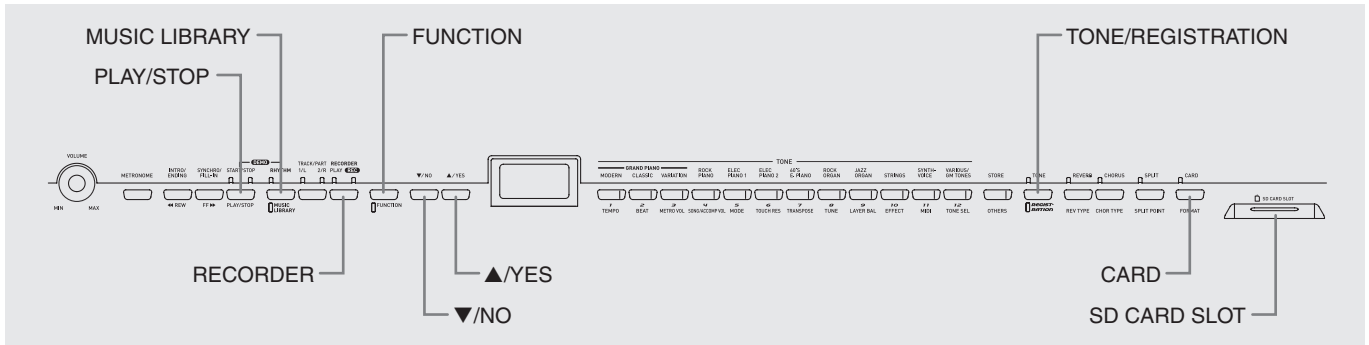

Your digital piano's SD memory card slot makes it possible for you to store song data on a commercially available SD memory card.



The digital piano also can read SMF song data and CASIO format song data from an SD memory card.

● Supported SD Memory Cards

The maximum supported SD memory card size is 2 GB. Use of any SD memory card with greater capacity is not supported.

● Supported Data File Types and SD Memory Card Operations

Data File Type	Display Indicator*1	File Name Extension	Supported SD Memory Card Operations
SMF Data (Format 0)	U (v)*2	.MID	Playback, transfer to user area
SMF Data (Format 1)*3	U (v)*2	.MID	Playback, transfer to user area
Song data converted to CASIO format using CASIO SMF conversion software (CASIO format)	C (d)	.CM2	Playback, transfer to user area
Song data recorded on the digital piano (CASIO format)	r (q)	.CSR	Save to SD memory card,*4 recall to recorder area
Registration data recorded on the digital piano (CASIO format)	G	.CR6	Save to SD memory card, recall to registration area

*1 If the first two characters of the filename of song data is not a two-digit number from 01 to 99, the corresponding letter (according to data type) shown in the parentheses will be displayed as the data type indicator.

The digital piano will no longer be able to access a registration data file if the file name is changed to a format that is not allowed.

*2 The display below shows the digital piano display for "v".



*3 The digital piano will not be able to correctly play a file that has more than 17 tracks.

*4 Song data recorded with the digital piano can be saved as SMF Format 0 data.

● Data File Display



Data File Type File Number (01 to 99)

IMPORTANT!

- Use only SD memory cards. Operation is not guaranteed when any other type of memory card is used.

SD Memory Card and SD Memory Card Slot Precautions

IMPORTANT!

- Whenever handling an SD memory card, be sure to observe the instructions and precautions in the user documentation that comes with it.
- SD memory cards have a write-protect switch that protects against accidental deletion of data.
- Avoid using an SD memory card in the following types of areas. Such conditions can corrupt data stored on the memory card.
 - Areas subjected to high temperature, high humidity, and corrosive gas
 - Areas subjected to strong electrostatic charge and digital noise
- Never touch the contacts of an SD memory card when loading it or when removing it from the digital piano.
- Never remove the SD memory card from the digital piano or turn off the digital piano while it is reading data from or writing data to the memory card. Doing so can corrupt the data on the memory card and damage the SD memory card slot.
- Exchange of data between the digital piano and an SD memory card can take anywhere from a few seconds to as long as a few minutes.
- Never insert anything besides an SD memory card into the SD memory card slot. Doing so creates the risk of malfunction.
- Inserting an SD memory card that carries an electrostatic charge into the SD memory card slot can cause malfunction of the digital piano. If this happens, turn the digital piano off and then back on again.
- An SD memory card can become quite warm after very long use in the SD memory card slot. This is normal and does not indicate malfunction.
- An SD memory card has a limited service life. After very long use, you may start to experience problems with storing data to, or reading or deleting data from the memory card. When this happens, you need to purchase a new SD memory card.

* Note that CASIO COMPUTER CO., LTD. shall not be held liable for any loss of data stored on an SD memory card.

Inserting and Removing an SD Memory Card

IMPORTANT!

- Note that the SD memory card must be oriented correctly when you insert it into the SD memory card slot. Trying to force the memory card into the slot can damage the card and the slot.
- Never remove the SD memory card from the card slot or turn off the digital piano while any data access operation (save, recall, format) is being performed. Doing so can corrupt the data on the memory card and damage the SD memory card slot.

■ To insert an SD memory card

1. With the SD memory card facing upwards as shown in the illustration, angle the card downwards as you insert it into the SD memory card slot.

- Push the card into the slot until you hear it click into place.

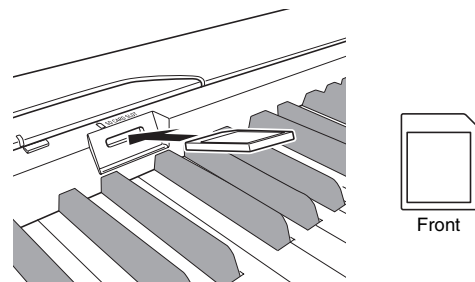

■ To remove an SD memory card

IMPORTANT!

- Before removing the SD memory card, check to make sure that the lamp above the **CARD** button is not lit. If the lamp is lit or flashing, it means that the card is being accessed, and that you should not remove it.

1. Press the memory card into the slot slightly and then release it.
 - This will cause the memory card to disengage and eject partially.
2. Pull the memory card out of the slot.

Formatting an SD Memory Card

Use the procedures in this section to format an SD memory card.

IMPORTANT!

- When using an SD Memory card, first be sure to format the memory card on the digital piano.
- Before performing the procedure below, check to make sure that the SD memory card does not contain any data you might need.
- The SD memory card format performed by your digital piano is a “quick format”. If you want to completely delete all of the data on the card, format it on your computer or using some other device.

PREPARATION

- Insert the SD memory card you want to format into the digital piano’s SD memory card slot. Make sure that the write-protect switch of the SD memory card is not in the write-protect position.

To format an SD memory card

1. Press the **FUNCTION** button.
 - This will cause the button’s lamp to flash.
2. Press the **CARD** button.
 - This will cause “For” (format) to flash on the display.
3. Press the **▲/YES** button to start formatting.
 - “PLS” (please wait) remains on the display while the formatting operation is performed. Never try to perform any other operation on the digital piano while the memory card is being formatted. The message “CPL” (complete) will appear on the display to let you know when the format operation is complete.
 - To cancel the format operation, press the **▼/NO** button in place of the **▲/YES** button in step 3.

Saving Recorded/Registration Data to an SD Memory Card

You can save song data that you recorded in the digital piano’s recorder area or registration data you saved to the registration area to an SD memory card. Song data also can be converted to SMF format 0 for storage.

PREPARATION

- Insert an SD memory card that has been formatted on the digital piano into the digital piano’s SD memory card slot. Make sure that the write-protect switch of the SD memory card is not in the write-protect position.

IMPORTANT!

- Never turn off the digital piano or perform any other operation while data is being saved to an SD memory card. Doing so can cause SD memory card data to be deleted and make impossible to store data to the card.

To save recorder area data

1. Press the **RECORDER** button so the **PLAY** lamp is lit.

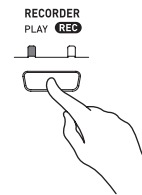

2. Use the **▼/NO** and **▲/YES** buttons to display the song number (1 through 5) of the song you want to save.



3. Hold down the **CARD** button until its lamp starts to flash slowly and “Ldr” (load recorder area) appears on the display.
4. Press the **CARD** button again.
 - This will cause the **CARD** button lamp to flash at a higher speed and “SvC” (save as CSR file) to appear on the display. This setting will save song data in CASIO CSR format.
 - If you want to save the song data in SMF Format 0, press the **CARD** button again. This will cause “SvS” (save as SMF0 file) to appear on the display.

5. Use the **▼/NO** and **▲/YES** buttons to display the file number where you want to save the song data.



This mark indicates that the currently displayed file number on the SD memory card has data stored already.

6. When everything is the way you want, press the **FUNCTION** button to begin saving data.

- The message "CPL" (complete) will appear on the display to let you know when the save operation is complete. After that, the digital piano will return to playback standby.
- To cancel the save operation, press the **CARD** button.
- If the SD memory card already contains a data file with the same file number, pressing the **FUNCTION** button in step 6 will display "rEP" (replace) to confirm that you want to replace the existing file with the file you are saving. Press the **▲/YES** button to overwrite the existing data file or the **▼/NO** button to cancel.

To save registration data

1. Press the **TONE/REGISTRATION** button so the registration lamp is lit.

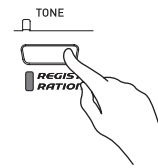

2. Hold down the **CARD** button until its lamp starts to flash slowly and "LdG" (load registration area) appears on the display.

3. Press the **CARD** button again.

- This will cause the **CARD** button lamp to flash at a higher speed and "SvG" (save as CR6 file) to appear on the display.

4. Use the **▼/NO** and **▲/YES** buttons to display the file number where you want to save the registration memory data.



This mark indicates that the currently displayed file number on the SD memory card has data stored already.

5. When everything is the way you want, press the **FUNCTION** button to begin saving data.

- The message "CPL" (complete) will appear on the display to let you know when the save operation is complete.
- To cancel the save operation, press the **CARD** button.
- If the SD memory card already contains a data file with the same file number, pressing the **FUNCTION** button in step 5 will display "rEP" (replace) to confirm that you want to replace the existing file with the file you are saving. Press the **▲/YES** button to overwrite the existing data file or the **▼/NO** button to cancel.

Transferring Data from an SD Memory Card to Digital Piano Memory

You can use the procedures in this section to transfer data from an SD memory card to the digital piano user area,^{*1} recorder area,^{*2} or registration area.^{*3}

*1 Music Library Songs 61 to 70

*2 Memory area where songs recorded on the digital piano are stored.

*3 Memory area where registration data on the piano is stored.

Supported Data

User Area	SMF format data and song data converted using SMF conversion software (CASIO CM2 format)
Recorder Area.....	Song data recorded on the digital piano (CASIO CSR format)
Registration Area...	Registration data saved with the digital piano (CASIO CR6 format)

PREPARATION

- Insert the SD memory card, which contains the data you want to transfer, into the piano's SD memory card slot.

IMPORTANT!

- Never turn off the digital piano or perform any other operation while data is being recalled from an SD memory card. Doing so can cause SD memory card data to be deleted or damaged, making transfer of the data impossible. It also can cause deletion of data stored in the area to which you are saving the data.

To transfer song data from an SD memory card to the digital piano user area

1. Press the **MUSIC LIBRARY** button so the lamp below the button is lit.

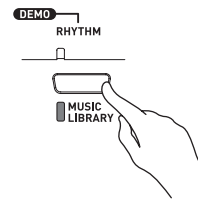

2. Use the **▼/NO** and **▲/YES** buttons to display the number of the user area song (Music Library song number 61 through 70) to which you want to transfer the song data.



This mark indicates that the currently displayed user area song number has data stored already.

3. Hold down the **CARD** button until its lamp starts to flash slowly and "LdU" (load user area) appears on the display.
4. Use the **▼/NO** and **▲/YES** buttons to display the file number of the song data you want to transfer to digital piano memory.



5. When everything is the way you want, press the **FUNCTION** button to begin data transfer.
 - The message "CPL" (complete) will appear on the display to let you know when data transfer is complete. After that, the display will change to show the number of the user area song to which the data was transferred.
 - To interrupt an ongoing data transfer operation, press the **CARD** button.
 - If the user area song number you select contains data already, pressing the **FUNCTION** button in step 5 will display "rEP" (replace) to confirm that you want to replace the existing data with the data you are transferring. Press the **▲/YES** button to overwrite the data or the **▼/NO** button to cancel.

To transfer song data from an SD memory card to the recorder area

1. Press the **RECORDER** button so the **PLAY** lamp is lit.

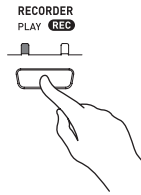

2. Use the **▼/NO** and **▲/YES** buttons to display the number of the recorder area song (1 through 5) to which you want to transfer the song data.



This mark indicates that the currently displayed song number has data stored already.

3. Hold down the **CARD** button until its lamp starts to flash slowly and “Ldr” (load recorder area) appears on the display.
4. Use the **▼/NO** and **▲/YES** buttons to display the file number of the song data you want to transfer to digital piano memory.



5. When everything is the way you want, press the **FUNCTION** button to begin data transfer.
 - The message “CPL” (complete) will appear on the display to let you know when data transfer is complete. The number of the recorder area song to which the data was transferred will be shown on the display.
 - To interrupt an ongoing data transfer operation, press the **CARD** button.
 - If the recorder area song number you select contains data already, pressing the **FUNCTION** button in step 5 will display “rEP” (replace) to confirm that you want to replace the existing data with the data you are transferring. Press the **▲/YES** button to overwrite the data or the **▼/NO** button to cancel.

To transfer registration data from an SD memory card to the registration area

1. Press the **TONE/REGISTRATION** button so the registration lamp is lit.

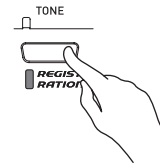

2. Hold down the **CARD** button until its lamp starts to flash slowly and “LdG” (load registration area) appears on the display.
3. Use the **▼/NO** and **▲/YES** buttons to display the file number of the registration data you want to transfer to digital piano memory.



4. When everything is the way you want, press the **FUNCTION** button to begin data transfer.
 - The message “rEP” (replace) will appear to confirm that you wish to overwrite existing data. Press the **▲/YES** button to recall the data. The message “CPL” (complete) will appear when data transfer is complete. To cancel the transfer operation, press the **▼/NO** button.
 - You can cancel the above operation any time before you press the **FUNCTION** button by pressing the **CARD** button twice.

Playing Back a File Stored on an SD Memory Card

Playback of SMF format data and song data converted using SMF conversion software to CASIO CM2 format.

IMPORTANT!

- Note the following important precautions whenever playing back a data file you copied to a memory card with a computer.
To perform the procedure below, you must have an SD memory card to which an SMF data file has been copied from a computer. Insert an SD memory card that has been formatted on the digital piano into the memory card slot of your computer, and copy the data file you want to play back from your computer into the memory card folder named "MUSICDAT". Note that you will not be able to play back the data on the digital piano if it is not located inside the "MUSICDAT" folder. If you create a sub-folder inside of the "MUSICDAT" folder, the digital piano will not be able to load any data file inside the sub-folder.
- After you select song data, it can take a number of seconds for it to be loaded. While the data is being loaded, the song number will flash on the display, and the keyboard keys and button operations will be disabled. Selecting a song while playing something on the keyboard will cause sound output of the keyboard notes to stop.

1. Press the **CARD** button.

- The **CARD** button lamp will light and a file number will appear on the display.



CASIO format song

2. Use the **▼/NO** and **▲/YES** buttons to display the song number of the song you want to play.

3. Press the **PLAY/STOP** button.

- This starts the playback of the song.
- The measure number appears on the display during playback.
- To view the song number during playback, hold down the **CARD** button.

4. Press the **PLAY/STOP** button again to stop playback.

5. After you are finished playing back files from the SD memory card, stop playback and then press the **CARD** button.

- This will cause the lamp above the button to go out.

NOTE

- You can change tempo, volume, and pre-count settings for playback. See "Other Settings" on page E-32 for more information.

SD Memory Card Errors

Display Message	Cause	Action
[noI]	No SD memory card loaded in the SD memory card slot or the card is not loaded correctly.	Correctly insert the SD memory card into the SD memory card slot. (Page E-42)
[noF]	You are trying to load data from an SD memory card that does not contain any data that is supported by this digital piano.	<ol style="list-style-type: none"> 1. Change to an SD memory card that contains data saved by or supported by this digital piano. 2. When copying data to an SD memory card from a computer, copy it to the "MUSICDAT" folder. (Page E-47)
[Er1]	The SD memory card is damaged or the card was removed while it was being accessed.	<ol style="list-style-type: none"> 1. Use an SD memory card that was formatted on the digital piano. (Page E-43) 2. Use a different SD memory card.
[Er2]	The SD memory card is full.	Use a different SD memory card.
[Er3]	An SD memory card was removed while some operation was in progress.	Never remove a card from the card slot while a card access operation is in progress.
[Er4]	Attempt to overwrite the song data file that is read-only.	Save the file to a different SD memory card or under a different number.
[Er5]	The data file you are trying to transfer to the digital piano is too large.	<p>When playing back a file stored on an SD memory card or loading data to the user area, select a data file that is no larger than about 318 KB.</p> <p>When loading song data to the recorder area, you can select only song data that was recorded on this model of digital piano.</p>
[Er6]	You are trying to load SMF (Standard MIDI File) data that is not Format 0 or Format 1.	Use only Format 0 or Format 1 SMF data.
[Er7]	You are trying to store data to an SD memory card that is write-protected.	<ol style="list-style-type: none"> 1. Use a different SD memory card. 2. If you want to write to the SD memory card, change the write-protect switch position to enable writing. (Page E-42)
[Er8]	There is a problem with the SD memory card data format or the data is corrupted.	Use different data or a different SD memory card.

Reference

Troubleshooting

Problem	Cause	Action	See Page
No sound is produced when I press a keyboard key.	<ol style="list-style-type: none"> 1. The VOLUME controller is set to "MIN". 2. Headphones are connected to the digital piano. 3. MIDI Local Control is turned off. 4. Check the current accompaniment mode setting. Normally, the accompaniment keyboard range will not produce any note while CASIO CHORD or FINGERED is selected as the Auto Accompaniment mode. 	<ol style="list-style-type: none"> 1. Rotate the VOLUME controller more towards "MAX". 2. Unplug the headphones from the digital piano. 3. Turn on the Local Control setting. 4. Change the accompaniment mode to NORMAL. 	<p>☞ E-10</p> <p>☞ E-7</p> <p>☞ E-36</p> <p>☞ E-18</p>
No rhythm	Accompaniment volume is set to 0.	Use the FUNCTION button and SONG/ACCOMP VOL button to increase the volume.	☞ E-35
The pitch of the digital piano is off.	<ol style="list-style-type: none"> 1. The digital piano's key setting is something other than "0". 2. Digital piano tuning is incorrect. 	<ol style="list-style-type: none"> 1. Change the key setting to "0", or turn digital piano power off and then back on again. 2. Adjust digital piano tuning, or turn the piano off and then back on again. 	<p>☞ E-35</p> <p>☞ E-35</p>
No sound is produced when I try to play back a built-in song or a recorded song.	<ol style="list-style-type: none"> 1. The VOLUME controller is set to "MIN". 2. Headphones are connected to the digital piano. 	<ol style="list-style-type: none"> 1. Rotate the VOLUME controller more towards "MAX". 2. Unplug the headphones from the digital piano. 	<p>☞ E-10</p> <p>☞ E-7</p>
When I play something on the digital piano, my connected external MIDI sound source does not sound.	<ol style="list-style-type: none"> 1. The digital piano's send channel is different from the send channel of the external MIDI sound source. 2. The volume or expression setting of the external sound source is "0". 	<ol style="list-style-type: none"> 1. Change the send channel settings of the digital piano and/or the external MIDI sound source so they are the same. 2. Adjust the volume and expression settings of the external sound source. 	<p>☞ E-36</p> <p>☞ External sound source user's guide</p>
No sound is produced when playing MIDI data from a computer.	The USB cable is not connected correctly.	Check to make sure that the USB cable is connected correctly.	☞ E-38
When connected to a computer over a USB connection, playing on the keyboard produces unnatural sounds.	The computer's MIDI THRU function is turned on.	Turn off MIDI THRU on the computer, or turn off digital piano Local Control.	☞ E-36
I can't record chord accompaniment data on my computer.	Accomp MIDI out is turned off.	Turn on Accomp MIDI out.	☞ E-36
I can't store data to an SD memory card.	<ol style="list-style-type: none"> 1. The SD memory card is write-protected. 2. The card is not inserted properly into the SD memory card slot. 3. There is not enough room available on the SD memory card. 4. The capacity of the SD memory card is not supported by the digital piano. 5. The SD memory card is damaged. 	<ol style="list-style-type: none"> 1. Change the write-protect switch position to enable writing. 2. Insert the card properly. 3. Use a different SD memory card. 4. Use an SD memory card with a supported capacity. 5. Use a different SD memory card. 	<p>☞ E-42</p> <p>☞ E-42</p> <p>☞ E-42</p> <p>☞ E-42</p>

Problem	Cause	Action	See Page
I can't load data from an SD memory card.	<ol style="list-style-type: none"> 1. The card is not inserted properly into the SD memory card slot. 2. The capacity of the SD memory card is not supported by the digital piano. 3. The SD memory card is damaged. 4. When the data was copied to the SD memory card from a computer, it was copied to a folder other than "MUSICDAT". 	<ol style="list-style-type: none"> 1. Insert the card properly. 2. Use an SD memory card with a supported capacity. 3. Use a different SD memory card. 4. Move the data to the "MUSICDAT" folder. 	<p>☞ E-42</p> <p>☞ E-42</p> <p>☞ E-47</p>
Playback stops part way through while transferring song data from my computer.	Digital noise from the USB cable or power cord caused data communication your computer and digital piano to be interrupted.	<p>Stop song playback, disconnect the USB cable from the digital piano, and then reconnect it. Next, try playing back the song again.</p> <p>If this does not solve the problem, quit the MIDI software you are using, disconnect the USB cable from the digital piano, and then reconnect it. Next, restart the MIDI software and then try playing back the song again.</p>	☞ E-38
"E-A" appears on the display immediately after power is turned on.	Built-in flash memory is corrupted.	Contact your nearest CASIO Service Center.	—
A tone's quality and volume sounds slightly different depending where it is played on the keyboard.	<p>This is an unavoidable result of the digital sampling process,* and does not indicate malfunction.</p> <p>* Multiple digital samples are taken for the low range, middle range, and high range of the original musical instrument. Because of this, there may be a very slight difference in tonal quality and volume between sample ranges.</p>		
When I press a button, the note that is sounding cuts out momentarily or there is a slight change in how effects are applied.	Selecting some tones or functions automatically changes internal effect settings that are unique the tone being used, which can cause such phenomena. This is due to the limitations of the digital piano's system, and does not indicate malfunction.		
Even though I play on different ranges of the keyboard, the notes do not change octaves.	The ranges of certain tones are limited, which means that octaves change normally up to a certain low note or high note. With such a tone, the notes of the lowest octave will be repeated to the left of the lowest possible note, and the highest octave will be repeated to the right of the highest possible note. This is due do limitations in the range of the original musical instrument for each tone, and does not indicate malfunction of the digital piano.		

Product Specifications

Model	PX-320
Keyboard	88-key piano keyboard, with Touch Response
Maximum Polyphony	128 notes
Tones	202 (with Layer and Split)
Effects	Reverb (4 types), Chorus (4 types), Brilliance (–3 to 0 to 3), Acoustic Resonance
Metronome	<ul style="list-style-type: none"> • Beats per measure: 0, 2, 3, 4, 5, 6 • Tempo Range: 20 to 255
Duet	Adjustable tone range: 0 to 3 octaves for the left keyboard; –4 to –1 octaves for the right keyboard
Auto Accompaniment	<ul style="list-style-type: none"> • Number of Rhythms: 70 • Tempo Range: 20 to 255 • Controllers: START/STOP, INTRO/ENDING, SYNCHRO/FILL-IN • Auto Accompaniment modes: NORMAL, CASIO CHORD, FINGERED, FULL RANGE CHORD • Accompaniment Volume Level: Adjustable
Demo Songs	71 (11 tone demo songs; 60 Music Library songs)
Music Library	<ul style="list-style-type: none"> • Built-in Songs: 60 • User Songs: Up to 10 (3.1 MB total memory capacity; up to approximately 318 KB per song)* * Based on 1 KB = 1024 bytes, 1 MB = 1024² bytes. • Song volume: Adjustable • Part On/Off: L, R
Registration	Number of Areas: 96 (12 sets × 8 banks)
Recorder	<ul style="list-style-type: none"> • Functions: Real-time recording, playback • Number of Songs: 5 • Number of Tracks: 2 • Capacity: Approximately 50,000 notes total (Up to approximately 10,000 notes per song) • Recording Media: Built-in flash memory
Pedals	Damper, Soft/Sostenuto (switchable)
Other Functions	<ul style="list-style-type: none"> • Touch Select: 3 types, Off • Transpose: ±1 octave (–12 to 0 to 12) • Tuning: A4 = 440.0 Hz ±99 cents (variable) • Operation Lock
MIDI	16-channel multi-timbre receive
SD Memory Card	<ul style="list-style-type: none"> • SD memory card slot • Supported SD Memory Cards: Up to 2 GB • Functions: SMF playback, file storage, file recall, card format
Inputs/Outputs	<ul style="list-style-type: none"> • PHONES jack: Stereo mini jacks × 2 • Pedal Jacks: Standard jacks × 2 • AC adaptor terminal: 12V DC • MIDI OUT/IN terminals • LINE OUT R, L/MONO jacks: Standard jacks × 2 Output impedance: 2.3KΩ Output voltage: 1.8V (RMS) MAX • LINE IN R, L/MONO jacks: Standard jacks × 2 Input impedance: 9.0KΩ Input voltage: 200mV • USB port: Type B • Pedal connector (for optional SP-30 only)
Speakers	(12cm × 6cm oval) × 2 + φ5cm × 2 (Output: 8.0W + 8.0W)
Power Requirements	AD-12 AC adaptor
Power Consumption	12V --- 18W
Dimensions	132.2 (W) × 27.8 (D) × 13.4 (H) cm (52 1/16 × 10 15/16 × 5 1/4 inch)
Weight	Approximately 12.0kg (26.4 lbs)

- Specifications and designs are subject to change without notice.

Operating Precautions

Be sure to read and observe the following operating precautions.

■ Location

Avoid the following locations for this product.

- Areas exposed to direct sunlight and high humidity
- Areas subjected to temperature extremes
- Near a radio, TV, video deck, or tuner

The above devices will not cause malfunction of the product, but the product can cause interference in the audio or video of a nearby device.

■ User Maintenance

- Never use benzene, alcohol, thinner, or other chemical agents to clean the product.
- To clean the product or its keyboard, wipe with a soft cloth moistened in a weak solution of water and a mild neutral detergent. Wring all excess moisture from the cloth before wiping.

■ Included and Optional Accessories

Use only accessories that are specified for use with this product. Use of unauthorized accessories creates the risk of fire, electric shock, and personal injury.

■ Weld Lines

Lines may be visible on the exterior of the product. These are “weld lines” that result from the plastic molding process. They are not cracks or scratches.

■ Musical Instrument Etiquette

Always be aware of others around you whenever using this product. Be especially careful when playing late at night to keep the volume at levels that do not disturb others. Other steps you can take when playing late at night are closing windows and using headphones.

- Any reproduction of the contents of this manual, either in part or its entirety, is prohibited. Except for your own, personal use, any other use of the contents of this manual without the consent of CASIO is prohibited under copyright laws.
- IN NO EVENT SHALL CASIO BE LIABLE FOR ANY DAMAGES WHATSOEVER (INCLUDING, WITHOUT LIMITATION, DAMAGES FOR LOSS OF PROFITS, BUSINESS INTERRUPTION, LOSS OF INFORMATION) ARISING OUT OF THE USE OF OR INABILITY TO USE THIS MANUAL OR PRODUCT, EVEN IF CASIO HAS BEEN ADVISED OF THE POSSIBILITY OF SUCH DAMAGES.
- The contents of this manual are subject to change without notice.

Appendix/Apéndice

Tone List/Lista de tonos

No./Nº	Tone Name/ Nombre de tonos	Program Change/ Cambio de programa	Bank Select MSB/ MSB de selección de banco	Maximum Polyphony/ Polifonía máxima	Acoustic Resonance/ Resonancia acústica
01	GRAND PIANO MODERN	0	48	64	○
02	GRAND PIANO CLASSIC	0	49	64	○
03	GRAND PIANO VARIATION	0	50	128	○
04	ROCK PIANO	1	48	64	○
05	ELEC PIANO 1	4	48	128	
06	ELEC PIANO 2	5	48	64	
07	60'S E.PIANO	4	51	128	
08	ROCK ORGAN	16	49	128	
09	JAZZ ORGAN	17	48	64	
10	STRINGS	49	48	128	
11	SYNTH-VOICE	54	48	128	
Various					
001	LA PIANO	1	49	128	○
002	MELLOW PIANO	0	51	64	○
003	MODERN PIANO	1	50	64	○
004	DANCE PIANO	1	51	128	○
005	STRINGS PIANO	0	52	64	○
006	PIANO PAD	0	53	64	○
007	HONKY-TONK	3	48	64	○
008	OCTAVE PIANO	3	49	64	○
009	E.GRAND 80	2	48	128	
010	DYNO ELEC.PIANO	4	49	128	
011	FM ELEC.PIANO	5	49	128	
012	MELLOW E.PIANO	4	50	64	
013	POP ELEC.PIANO	5	50	64	
014	SYNTH-STR E.PIANO	4	52	64	
015	CLAVI	7	48	128	
016	HARPSICHORD	6	48	128	
017	COUPLED HARPSICHORD	6	49	64	
018	VIBRAPHONE	11	48	128	
019	MARIMBA	12	48	128	
020	DRAWBAR ORGAN	16	48	128	
021	ROTARY DRAWBAR	16	50	128	
022	ROTARY ORGAN	16	51	128	
023	PERC.ORGAN	17	49	128	
024	70'S ORGAN	17	50	128	
025	OVERDRIVE ORGAN	16	52	128	
026	TREMOLO ORGAN	16	53	128	
027	CHURCH ORGAN	19	48	64	
028	CHAPEL ORGAN	19	49	128	
029	NYLON STR.GUITAR	24	48	128	
030	STEEL STR.GUITAR	25	48	128	
031	JAZZ GUITAR	26	48	128	
032	CHORUS CLEAN GUITAR	27	48	128	
033	OVERDRIVE GUITAR	29	48	64	
034	ACOUSTIC BASS	32	48	128	
035	RIDE BASS	32	49	64	
036	FINGERED BASS	33	48	128	
037	STRING ENSEMBLE	48	48	128	
038	SYNTH-STRINGS	50	48	128	
039	70'S SYNTH-STR	50	49	128	
040	80'S SYNTH-STR	50	50	128	
041	CHOIR	52	48	64	
042	TRUMPET	56	48	128	
043	TROMBONE	57	48	128	
044	STEREO BRASS	61	48	128	
045	SYNTH-BRASS	62	48	64	
046	80'S SYNTH-BRASS	62	49	64	
047	BREATHY ALTO SAX	65	49	64	

No./Nº	Tone Name/ Nombre de tonos	Program Change/ Cambio de programa	Bank Select MSB/ MSB de selección de banco	Maximum Polyphony/ Polifonía máxima	Acoustic Resonance/ Resonancia acústica
048	BREATHY TENOR SAX	66	49	64	
049	ALTO SAX	65	48	128	
050	TENOR SAX	66	48	128	
051	CLARINET	71	48	128	
052	FLUTE	73	48	128	
053	SAWTOOTH LEAD	81	48	64	
054	MELLOW SAW LEAD	81	49	64	
055	SQUARE LEAD	80	48	64	
056	SYNTH-PAD	90	48	64	
057	FANTASY	88	48	64	
058	NEW AGE	88	49	64	
059	WARM PAD	89	48	128	
060	WARM VOX	89	49	64	
061	POLYSYNTH PAD	90	49	64	
GM					
062	GM PIANO 1	0	0	128	
063	GM PIANO 2	1	0	128	
064	GM PIANO 3	2	0	128	
065	GM HONKY-TONK	3	0	64	
066	GM E.PIANO 1	4	0	128	
067	GM E.PIANO 2	5	0	128	
068	GM HARPSICHORD	6	0	128	
069	GM CLAVI	7	0	128	
070	GM CELESTA	8	0	128	
071	GM GLOCKENSPIEL	9	0	128	
072	GM MUSIC BOX	10	0	64	
073	GM VIBRAPHONE	11	0	128	
074	GM MARIMBA	12	0	128	
075	GM XYLOPHONE	13	0	128	
076	GM TUBULAR BELL	14	0	128	
077	GM DULCIMER	15	0	64	
078	GM ORGAN 1	16	0	128	
079	GM ORGAN 2	17	0	64	
080	GM ORGAN 3	18	0	64	
081	GM PIPE ORGAN	19	0	64	
082	GM REED ORGAN	20	0	128	
083	GM ACCORDION	21	0	64	
084	GM HARMONICA	22	0	128	
085	GM BANDONEON	23	0	64	
086	GM NYLON STR.GUITAR	24	0	128	
087	GM STEEL STR.GUITAR	25	0	128	
088	GM JAZZ GUITAR	26	0	128	
089	GM CLEAN GUITAR	27	0	128	
090	GM MUTE GUITAR	28	0	128	
091	GM OVERDRIVE GT	29	0	64	
092	GM DISTORTION GT	30	0	64	
093	GM GT HARMONICS	31	0	128	
094	GM ACOUSTIC BASS	32	0	128	
095	GM FINGERED BASS	33	0	128	
096	GM PICKED BASS	34	0	128	
097	GM FRETLESS BASS	35	0	128	
098	GM SLAP BASS 1	36	0	128	
099	GM SLAP BASS 2	37	0	128	
100	GM SYNTH-BASS 1	38	0	64	
101	GM SYNTH-BASS 2	39	0	128	
102	GM VIOLIN	40	0	128	
103	GM VIOLA	41	0	128	
104	GM CELLO	42	0	128	
105	GM CONTRABASS	43	0	128	
106	GM TREMOLO STRINGS	44	0	128	
107	GM PIZZICATO	45	0	128	

No./ N°	Tone Name/ Nombre de tonos	Program Change/ Cambio de programa	Bank Select MSB/ MSB de selección de banco	Maximum Polyphony/ Polifonía máxima	Acoustic Resonance/ Resonancia acústica
108	GM HARP	46	0	128	
109	GM TIMPANI	47	0	128	
110	GM STRINGS 1	48	0	128	
111	GM STRINGS 2	49	0	128	
112	GM SYNTH-STRINGS 1	50	0	128	
113	GM SYNTH-STRINGS 2	51	0	128	
114	GM CHOIR AAHS	52	0	128	
115	GM VOICE DOO	53	0	128	
116	GM SYNTH-VOICE	54	0	128	
117	GM ORCHESTRA HIT	55	0	64	
118	GM TRUMPET	56	0	128	
119	GM TROMBONE	57	0	128	
120	GM TUBA	58	0	128	
121	GM MUTE TRUMPET	59	0	128	
122	GM FRENCH HORN	60	0	64	
123	GM BRASS	61	0	128	
124	GM SYNTH-BRASS 1	62	0	64	
125	GM SYNTH-BRASS 2	63	0	64	
126	GM SOPRANO SAX	64	0	128	
127	GM ALTO SAX	65	0	128	
128	GM TENOR SAX	66	0	128	
129	GM BARITONE SAX	67	0	128	
130	GM OBOE	68	0	128	
131	GM ENGLISH HORN	69	0	128	
132	GM BASSOON	70	0	128	
133	GM CLARINET	71	0	128	
134	GM PICCOLO	72	0	128	
135	GM FLUTE	73	0	128	
136	GM RECORDER	74	0	128	
137	GM PAN FLUTE	75	0	128	
138	GM BOTTLE BLOW	76	0	128	
139	GM SHAKUHACHI	77	0	64	
140	GM WHISTLE	78	0	128	
141	GM OCARINA	79	0	128	
142	GM SQUARE LEAD	80	0	64	
143	GM SAWTOOTH LEAD	81	0	64	
144	GM CALLIOPE	82	0	64	
145	GM CHIFF LEAD	83	0	64	
146	GM CHARANG	84	0	64	
147	GM VOICE LEAD	85	0	64	
148	GM FIFTH LEAD	86	0	64	
149	GM BASS+LEAD	87	0	64	
150	GM FANTASY	88	0	64	
151	GM WARM PAD	89	0	128	
152	GM POLYSYNTH	90	0	64	
153	GM SPACE CHOIR	91	0	64	
154	GM BOWED GLASS	92	0	64	
155	GM METAL PAD	93	0	64	
156	GM HALO PAD	94	0	64	
157	GM SWEEP PAD	95	0	128	
158	GM RAIN DROP	96	0	64	
159	GM SOUND TRACK	97	0	64	
160	GM CRYSTAL	98	0	64	
161	GM ATMOSPHERE	99	0	64	
162	GM BRIGHTNESS	100	0	64	
163	GM GOBLINS	101	0	64	
164	GM ECHOES	102	0	128	
165	GM SF	103	0	64	
166	GM SITAR	104	0	128	
167	GM BANJO	105	0	128	
168	GM SHAMISEN	106	0	128	
169	GM KOTO	107	0	128	
170	GM THUMB PIANO	108	0	128	
171	GM BAGPIPE	109	0	64	
172	GM FIDDLE	110	0	128	
173	GM SHANAI	111	0	128	
174	GM TINKLE BELL	112	0	128	
175	GM AGOGO	113	0	128	
176	GM STEEL DRUMS	114	0	64	

No./ N°	Tone Name/ Nombre de tonos	Program Change/ Cambio de programa	Bank Select MSB/ MSB de selección de banco	Maximum Polyphony/ Polifonía máxima	Acoustic Resonance/ Resonancia acústica
177	GM WOOD BLOCK	115	0	128	
178	GM TAIKO	116	0	128	
179	GM MELODIC TOM	117	0	128	
180	GM SYNTH-DRUM	118	0	128	
181	GM REVERSE CYMBAL	119	0	128	
182	GM GT FRET NOISE	120	0	128	
183	GM BREATH NOISE	121	0	128	
184	GM SEASHORE	122	0	64	
185	GM BIRD	123	0	64	
186	GM TELEPHONE	124	0	128	
187	GM HELICOPTER	125	0	128	
188	GM APPLAUSE	126	0	64	
189	GM GUNSHOT	127	0	128	
Drum Sets					
190	STANDARD SET	0	120	128	—
191	BRUSH SET	40	120	128	—

 **NOTE**

- Acoustic resonance (page E-34) is applied only to tones indicated by “○”.

 **NOTA**

- La resonancia acústica (página S-34) se aplica solamente a los tonos indicados mediante “○”.

Drum Assignment List/ Lista de sonidos de batería

Key/Note Number Número de clave/nota	STANDARD SET	BRUSH SET
E1 28	HIGH Q	←
	SLAP	←
F1 29	SCRATCH PUSH	←
	SCRATCH PULL	←
G1 31	STICKS	←
	SQUARE CLICK	←
A1 33	METRONOME CLICK	←
	METRONOME BELL	←
B1 35	STANDARD 1 KICK 2	BRUSH KICK 2
	STANDARD 1 KICK 1	BRUSH KICK 1
C2 36	SIDE STICK	BRUSH SIDE STICK
	STANDARD 1 SNARE 1	BRUSH TAP
D2 38	HAND CLAP 1	BRUSH SLAP
	STANDARD 1 SNARE 2	BRUSH SWIRL
F2 41	LOW TOM 2	←
	CLOSED HI-HAT	←
G2 43	LOW TOM 1	←
	PEDAL HI-HAT	←
A2 45	MID TOM 2	←
	OPEN HI-HAT	←
B2 47	MID TOM 1	←
	HIGH TOM 2	←
C3 48	CRASH CYMBAL 1	BRUSH CRASH CYMBAL 1
D3 50	HIGH TOM 1	←
	RIDE CYMBAL 1	BRUSH RIDE CYMBAL 1
E3 52	CHINESE CYMBAL	←
	RIDE BELL	BRUSH RIDE BELL
F3 53	TAMBOURINE 1	TAMBOURINE 2
	SPLASH CYMBAL	BRUSH SPLASH CYMBAL
G3 55	COWBELL	←
	CRASH CYMBAL 2	BRUSH CRASH CYMBAL 2
A3 57	VIBRA-SLAP	←
	RIDE CYMBAL 2	BRUSH RIDE CYMBAL 2
B3 59	HIGH BONGO	←
	LOW BONGO	←
C4 60	MUTE HIGH CONGA	←
D4 62	OPEN HIGH CONGA	←
	LOW CONGA	←
E4 64	HIGH TIMBALE	←
	LOW TIMBALE	←
F4 65	HIGH AGOGO	←
	LOW AGOGO	←
G4 67	CABASA	←
	MARACAS	←
A4 69	SHORT HI WHISTLE	←
	LONG LOW WHISTLE	←
B4 71	SHORT GUIRO	←
	LONG GUIRO	←
C5 72	CLAVES	←
D5 74	HIGH WOOD BLOCK	←
	LOW WOOD BLOCK	←
E5 76	MUTE CUICA	←
	OPEN CUICA	←
F5 77	MUTE TRIANGLE	←
	OPEN TRIANGLE	←
G5 79	SHAKER	←
	JINGLE BELL	←
A5 81	BELL TREE	←
	CASTANETS	←
B5 83	MUTE SURDO	←
	OPEN SURDO	←
C6 84	APPLAUSE	←
D6 86	APPLAUSE 2	←
E6 88		
F6 89		

NOTE

- “←” : indicates the same sound as STANDARD SET.

NOTA

- “←” : indica el mismo sonido que STANDARD SET.

Rhythm List/Lista de ritmos

Category/Categoría	No./Nº	Rhythm Name/ Nombre de ritmo
8BEAT/16BEAT	01	STRAIGHT 8 BEAT
	02	MELLOW 8 BEAT
	03	GUITAR 8 BEAT
	04	8 BEAT POP
	05	16 BEAT
	06	16 BEAT SHUFFLE
BALLAD	07	SLOW BALLAD
	08	POP BALLAD
	09	6/8 BALLAD
	10	ROCK BALLAD
POPS	11	POP
	12	POP ROCK
	13	FAST SOUL
	14	60'S SOUL
	15	DISCO SOUL
ROCK	16	SHUFFLE ROCK
	17	BLUES
	18	SOFT ROCK
	19	SLOW ROCK
	20	NEW ORLNS R&R
	21	ROCK WALTZ
JAZZ	22	SLOW BIG BAND
	23	FAST BIG BAND
	24	SWING
	25	SLOW SWING
	26	JAZZ WALTZ
	27	FOX TROT
	28	QUICKSTEP
	29	JAZZ COMBO 1
EUROPEAN	30	POLKA
	31	WALTZ 1
	32	VIENNESE WALTZ
	33	FRENCH WALTZ
	34	TANGO
LATIN	35	MARCH 1
	36	BOSSA NOVA
	37	BEGUINE
	38	SAMBA
	39	MAMBO
	40	RHUMBA
	41	CHA-CHA-CHA
	42	BOLERO
	43	SALSA
	44	REGGAE
VARIOUS	45	COUNTRY 8 BEAT
	46	COUNTRY BALLAD
	47	COUNTRY SHUFFLE
	48	FAST GOSPEL
	49	SLOW GOSPEL
	50	STR QUARTET

Category/Categoría	No./Nº	Rhythm Name/ Nombre de ritmo
FOR PIANO	51	PIANO 8 BEAT
	52	PIANO BALLAD 1
	53	PIANO BALLAD 2
	54	EP BALLAD 1
	55	EP BALLAD 2
	56	BLUES BALLAD
	57	JAZZ COMBO 2
	58	JAZZ COMBO 3
	59	RAGTIME
	60	PIANO ROCK'N'ROLL
	61	BOOGIE-WOOGIE
	62	ARPEGGIO 1
	63	ARPEGGIO 2
	64	ARPEGGIO 3
	65	MARCH 2
	66	MARCH 3
	67	STRIDE PIANO
	68	WALTZ 2
	69	WALTZ 3
	70	WALTZ 4

Song List/Lista de canciones

Tone Demo/Demostración de tonos

No./Nº	Tone Name/ Nombre de tonos	Song Name/ Nombre de canciones
01	GRAND PIANO (MODERN)	Pr_lude [Suite bergamasque]
02	GRAND PIANO (CLASSIC)	3 Romances Sans Paroles 3
03	GRAND PIANO (VARIATION)	Ungarischer Tanz 5
04	ROCK PIANO	Original
05	ELEC PIANO 1	Original
06	ELEC PIANO 2	Original
07	60's E.PIANO	Original
08	ROCK ORGAN	Original
09	JAZZ ORGAN	Original
10	STRINGS	Nessun Dorma [Turandot]
11	SYNTH-VOICE	Original

Music Library/Biblioteca musical

No./Nº	Song Name/Nombre de canciones
01	Nocturne Op.9-2
02	Fantaisie-Improptu Op.66
03	Étude Op.10-3 "Chanson de l'adieu"
04	Étude Op.10-5 "Black Keys"
05	Étude Op.10-12 "Revolutionary"
06	Étude Op.25-9 "Butterflies"
07	Prélude Op.28-7
08	Valse Op.64-1 "Petit Chien"
09	Valse Op.64-2
10	Moments Musicaux 3
11	Impromptu Op.90-2
12	Marche Militaire 1 (Duet)
13	Frühlingslied [Lieder Ohne Worte Heft 5]
14	Fröhlicher Landmann [Album für die Jugend]
15	Von fremden Ländern und Menschen [Kinderszenen]
16	Träumerei [Kinderszenen]
17	Tambourin
18	Menuet BWV Anh.114 [Clavierbüchlein der Anna Magdalena Bach]
19	Inventio 1 BWV 772
20	Inventio 8 BWV 779
21	Inventio 13 BWV 784
22	Praeludium 1 BWV 846 [Das Wohltemperierte Klavier 1]
23	Le Coucou
24	Gavotte
25	Sonatina Op.36-1 1st Mov.
26	Sonatine Op.20-1 1st Mov.
27	Sonate K.545 1st Mov.
28	Sonate K.331 3rd Mov. "Turkish March"
29	Rondo K.485
30	Für Elise
31	Marcia alla Turca
32	Sonate Op.13 "Pathétique" 1st Mov.
33	Sonate Op.13 "Pathétique" 2nd Mov.
34	Sonate Op.13 "Pathétique" 3rd Mov.
35	Sonate Op.27-2 "Moonlight" 1st Mov.
36	Rhapsodie 2
37	Waltz Op.39-15 (Duet)
38	Liebesträume 3
39	Blumenlied
40	La Prière d'une Vierge
41	Csikos Post
42	Humoresque Op.101-7
43	Melodie [Lyrische Stücke Heft 2]
44	Sicilienne Op.78
45	Berceuse [Dolly] (Duet)
46	Arabesque 1
47	La Fille aux Cheveux de Lin [Préludes]
48	Passepied [Suite bergamasque]
49	Gymnopédie 1
50	Je Te Veux
51	Salut d'Amour
52	The Entertainer
53	Maple Leaf Rag
54	L'arabesque [25 Étüden Op.100]
55	La Styrienne [25 Étüden Op.100]
56	Ave Maria [25 Étüden Op.100]
57	Le retour [25 Étüden Op.100]
58	La chevaleresque [25 Étüden Op.100]
59	No.13 [Études de Mécanisme Op.849]
60	No.26 [Études de Mécanisme Op.849]
61-70	User area songs/Canciones del área de usuario

Fingered Chord Chart/Cuadro de acordes digitados (Fingered)

Chord Type Root	M	m	7	m7	dim7	M7	dim	m7 ^{♭5}
C								
C [♯] (D [♭])								
D								
(D [♯])/E [♭]								
E								
F								
F [♯] (G [♯])								
G								
(G [♯])/A [♭]								
A								
(A [♯])/B [♭]								
B								

Chord Type Root	aug	sus4	7sus4	m add9	mM7	7 ^{♭5}	add9
C							
C [♯] (D [♭])							
D							
(D [♯])/E [♭]							
E							
F							
F [♯] (G [♯])							
G							
(G [♯])/A [♭]							
A							
(A [♯])/B [♭]							
B							



This recycle mark indicates that the packaging conforms to the environmental protection legislation in Germany.

Esta marca de reciclaje indica que el empaquetado se ajusta a la legislación de protección ambiental en Alemania.

CASIO®